FREEDOM DENTAL SYSTEM

Operation & Service Manual

Document No. 65-OS05, Rev-D, 07/15/25

Dental Operative Unit

Models: 90-1044
90-1054
90-2042
90-2044
90-2044S
90-2054

This guide provides important steps for setup, use, and maintenance of the ASI delivery system. It includes important details which must be followed to ensure safety and proper use. Any serious incidents that occur in relation to the device should be reported to the manufacturer and to the competent authority of the relevant location of use.

This document includes sections for optional components that may or may not be included in your system. Your system may contain built-in accessory instruments from other manufacturers. Please refer to the original manufacturer's instructions for operation and maintenance for those instruments.



ASI MEDICAL INC. | 8811 American Way, Suite 130, Englewood, CO 80112
Advanced Dental Systems® & Advanced Endodontic Systems®
Customer Support Team | www.asisupport.com | 303-407-6072

- 1 SYMBOLS & SAFETY PRECAUTIONS**
- 2 OPERATING ENVIRONMENT & CLASSIFICATION OF EQUIPMENT**
- 3 PRODUCT DESCRIPTION, SPECIFICATIONS & WARRANTY**
 - Intended Use
 - Product Description / Theory of Operation
 - Dimensions, Specifications & Technical Data
 - Warranty Information
- 4 UNPACKING & INSTALLATION**
- 5 START UP, OPERATION & SHUT DOWN**
- 6 CLEANING/DISINFECTING, STORAGE & SHIPPING**
- 7 TROUBLESHOOTING**
- 8 SERVICING & PREVENTATIVE MAINTENANCE**
- 9 SCHEMATICS, DIAGRAMS & PARTS LISTING**
- 10 REFERENCES OR SUPPLEMENTAL INFORMATION (OPTIONAL)**

Section 1 Contents

Symbols & Safety Precautions

SYMBOLS

DESCRIPTION OF DANGER LEVELS

GENERAL SAFETY PRECAUTIONS

IDENTIFICATION OF SYMBOLS

SYMBOLS

These symbols are used in this manual.



Important information for users and technicians



Warning Symbol

SYMBOLES

Ces symboles sont utilisés dans ce manuel.

Informations importantes pour les utilisateurs et les techniciens

Symbole d'avertissement

DESCRIPTION OF DANGER LEVELS

DESCRIPTION DES NIVEAUX DE DANGER



⚠ DANGER

DANGER indicates a maximum hazardous situation that can directly cause serious injury or death.

⚠ DANGER

DANGER indique une situation dangereuse maximale qui peut directement causer des blessures graves à la mort.



⚠ WARNING

WARNING indicates a hazardous situation that can lead to serious injury or death.

⚠ AVERTISSEMENT

L'AVERTISSEMENT indique une situation dangereuse qui peut entraîner des blessures graves.



⚠ CAUTION

CAUTION indicates a hazardous situation that can lead to property damage or minor to moderate injury.

⚠ MISE EN GARDE

LA PRUDENCE indique une situation dangereuse qui peut entraîner des dommages matériels ou des blessures mineures à modérées.

GENERAL SAFETY PRECAUTIONS

In addition to observing the normal precautions associated with standard dental practices and procedures, the following precautions should be strictly noted and observed during the set-up, operation, and maintenance of this system.

PRÉCAUTIONS GÉNÉRALES DE SÉCURITÉ

En plus d'observer les précautions normales associées aux pratiques et procédures dentaires standard, les précautions suivantes doivent être strictement notées et observées pendant la configuration, le fonctionnement et l'entretien de ce système.



⚠ WARNING

QUALIFIED PERSONNEL ONLY

The product should only be operated by or under the supervision of a licensed dentist or a hygienist if permitted by applicable law. The operator bears responsibility for the correct settings and proper use of the system. ASI Medical, Inc. (ASI) cannot be held liable for any malfunction of this product, or performance failure and/or its designed or desired utility, nor can ASI be held liable for injuries to persons or animals, in any case when the device is misused or not operated, applied or maintained in strict accordance with user/owner instructions set out in the operation manual. In the event of any doubt or question, the user is to contact ASI for clarification or assistance.

⚠ AVERTISSEMENT

PERSONNEL QUALIFIÉ UNIQUEMENT

Le produit ne doit être utilisé que par du personnel qualifié. L'exploitant est responsable des réglages corrects et de l'utilisation correcte du système. ASI Dental (ASI) ne peut être tenu responsable de tout dysfonctionnement de ce produit, ou d'une défaillance de performance et/ou de son utilité conçue ou souhaitée, et ASI ne peut être tenu responsable des blessures aux personnes ou aux animaux, en tout cas lorsque l'appareil est mal utilisé ou pas utilisé, appliqué ou entretenu en stricte conformité avec les instructions de l'utilisateur/propriétaire énoncées dans le manuel d'utilisation. En cas de doute ou de question, l'utilisateur doit contacter ASI pour obtenir des éclaircissements ou de l'aide.

Des systèmes ou instruments mal entretenus ou mal exploités peuvent annuler les garanties associées.



⚠ WARNING

PRESENCE OF HEAVY METALS/AMALGAM

This system may be equipped with optional suction instruments. As part of dental procedures, particles of amalgam may be suctioned into the dental suction handpieces and collected within the system and trap filter. Recycle amalgam in accordance with local guidelines.

⚠ AVERTISSEMENT

PRÉSENCE DE MÉTAUX LOURDS/AMALGAME

Ce système peut être équipé d'instruments d'aspiration en option. Dans le cadre de procédures dentaires, des particules d'amalgame peuvent être aspirées dans les pièces à main d'aspiration dentaire et collectées dans le système et le filtre piège.



⚠ WARNING

CONTAINS HAZARDOUS SUBSTANCES

This system contains substances that may be carcinogenic, mutagenic, reprotoxic (CMR), or substances with endocrine disrupting properties and may pose additional risks to those who are pregnant or nursing.

⚠ AVERTISSEMENT

CONTIENT DES SUBSTANCES DANGEREUSES

Ce système contient des substances qui peuvent être cancérogènes, mutagènes, toxiques pour la reproduction (CMR) ou des substances ayant des propriétés perturbant le système endocrinien et peuvent présenter des risques supplémentaires pour les femmes enceintes ou allaitantes



⚠ WARNING

INFECTIOUS MATERIALS

Infectious disease workplace safety protocols to safeguard against cross contamination of infectious disease should always be observed. When maintaining the suction system or emptying the contents of the suction waste container, safe precautions and practices including the wearing of face mask, eye protection and gloves are to be followed.

⚠ AVERTISSEMENT

MATIERES INFECTIEUSES

Les protocoles de sécurité sur le lieu de travail contre les maladies infectieuses pour se prémunir contre la contamination croisée des maladies infectieuses doivent toujours être observés. Lors de l'entretien du système d'aspiration ou de la vidange du contenu du conteneur de déchets d'aspiration, des précautions et des pratiques de sécurité, notamment le port d'un masque facial, d'une protection oculaire et de gants, doivent être suivies.



⚠ CAUTION

CAUSTIC OR CORROSIVE CHEMICALS

The irrigation system may contain chemicals that are caustic or corrosive. Always verify with the operator of the system to determine which chemicals they are using within the system. Always follow workplace safety protocols when doing maintenance or service of the system including the wearing of face mask, eye protection and gloves for proper protection of exposed skin, breathing and eyes.

⚠ MISE EN GARDE

PRODUITS CHIMIQUES CAUSTIQUES OU CORROSIFS

Le système d'irrigation peut contenir des produits chimiques caustiques ou corrosifs. Vérifiez toujours auprès de l'opérateur du système pour déterminer quels produits chimiques ils utilisent dans le système. Suivez toujours les protocoles de sécurité sur le lieu de travail lors de la maintenance ou de l'entretien du système, y compris le port d'un masque facial, d'une protection oculaire et de gants pour une protection adéquate de la peau, de la respiration et des yeux exposés.



⚠ WARNING

ELECTRICAL HAZARD POSSIBLE!

Do not connect any additional multiple socket outlets or extension cables to the product.

⚠ AVERTISSEMENT

DANGER ÉLECTRIQUE POSSIBLE!

Ne connectez pas de prises de courant ou de câbles d'extension supplémentaires au produit.



⚠ WARNING

ELECTROMAGNETIC COMPATIBILITY (EMC)

Changes or modifications to this product not expressly approved by the manufacturer may result in increased emissions or decreased immunity performance of the product and could cause EMC issues with this or other equipment. This product is designed and tested to comply with applicable regulation regarding EMC and shall be installed and put into service according to the EMC information stated below:

⚠ WARNING

Use of portable phones or other portable or mobile radio frequency (RF) emitting equipment near the product may cause unexpected or adverse operation.

⚠ WARNING

The use of accessories, transducers, and cables other than those supplied may result in increased emissions or decreased immunity performance of the product. The product shall not be used adjacent to, or stacked with, other equipment. If adjacent or stacked use is necessary, the user shall be responsible to test to verify normal operation in the configuration in which it is being used.

⚠ AVERTISSEMENT

COMPATIBILITÉ ÉLECTROMAGNÉTIQUE (CEM)

Les changements ou modifications apportés à ce produit non expressément approuvés par le fabricant peuvent entraîner une augmentation des émissions ou une diminution des performances d'immunité du produit et peuvent entraîner des problèmes de compatibilité électromagnétique avec cet équipement ou d'autres. Ce produit est conçu et testé pour se conformer à la réglementation applicable en matière de CEM et doit être installé et mis en service conformément aux informations CEM indiquées ci-dessous :

⚠ AVERTISSEMENT

L'utilisation de téléphones portables ou d'autres équipements portables ou mobiles émettant des radiofréquences (RF) à proximité du produit peut provoquer un fonctionnement inattendu ou indésirable.

⚠ AVERTISSEMENT

L'utilisation d'accessoires, de transducteurs et de câbles autres que ceux fournis peut entraîner une augmentation des émissions ou une diminution des performances d'immunité du produit. Le produit ne doit pas être utilisé à côté ou empilé avec d'autres équipements. Si une utilisation adjacente ou empilée est nécessaire, l'utilisateur sera responsable de tester pour vérifier le fonctionnement normal dans la configuration dans laquelle il est utilisé.



⚠ WARNING

ELECTRICAL VOLTAGE

This system is powered by high voltage electricity. Like any other electrically powered device, if it is not used properly, it can cause electrical shock. Always plug the power cord into an electrical outlet with adequate fuse protection and proper grounding. In the event of a short circuit, grounding reduces the risk of shock by providing an escape wire for the electric current. Improper grounding of the unit can result in a risk of electric shock. Always unplug the unit before doing any service or repair to the unit.

⚠ AVERTISSEMENT

TENSION ELECTRIQUE

Ce système est alimenté par de l'électricité à haute tension. Comme tout autre appareil électrique, s'il n'est pas utilisé correctement, il peut provoquer un choc électrique. Branchez toujours le cordon d'alimentation dans une prise électrique avec une protection par fusible adéquate et une mise à la terre appropriée. En cas de court-circuit, la mise à la terre réduit le risque d'électrocution en fournissant un fil d'échappement pour le courant électrique. Une mauvaise mise à la terre de l'appareil peut entraîner un risque d'électrocution. Débranchez toujours l'appareil avant d'effectuer tout entretien ou réparation sur l'appareil.



⚠ WARNING

COMPRESSED AIR

The compressed air system that operates this unit is under pressure. Compressed air can propel dust or loose particles and can cause bodily injury or damage. Always turn the system off and bleed off air pressure before attaching or removing air lines or accessories or servicing this unit. All air lines should be periodically inspected and replaced if worn or damaged.

If an outside compressed air supply is used to power this unit, the air supply must be regulated to 80 psi or below. Excessive air pressure could cause certain components to rupture.

⚠ AVERTISSEMENT

AIR COMPRIMÉ

Le système d'air comprimé qui fait fonctionner cet appareil est sous pression. L'air comprimé peut propulser de la poussière ou des particules libres et peut causer des blessures ou des dommages corporels. Éteignez toujours le système et purgez la pression d'air avant de fixer ou de retirer les conduites d'air ou les accessoires ou de procéder à l'entretien de cet appareil. Toutes les conduites d'air doivent être inspectées périodiquement et remplacées si elles sont usées ou endommagées.

Si une alimentation extérieure en air comprimé est utilisée pour alimenter cet appareil, l'alimentation en air doit être régulée à 80 psi ou moins. Une pression d'air excessive peut entraîner la rupture de certains composants.



CAUTION

DISPOSAL

In compliance with Directives 2012/19/EU and 2006/66/EC, components with batteries or containing hazardous substances must be disposed of in accordance with waste legislation and instructions issued by the local environmental authorities. Any components which can be recycled, such as sheet metal, should always be taken to the appropriate processing centers. The following components may potentially contain batteries or hazardous substances:

- Instrument Control Boards
- Amalgam separator(s)
- Sediment tank(s)
- Suction System Components

MISE EN GARDE

DISPOSITION

Conformément aux directives 2012/19/EU et 2006/66/EC, les composants contenant des batteries ou contenant des substances dangereuses doivent être éliminés conformément à la 5ells5es5on sur les déchets et les instructions émises par les autorités environnementales locales. Tous les composants qui peuvent être 5ells5es, 5ells que la tôle, doivent toujours être apportés aux centres de traitement appropriés. Les composants suivants peuvent potentiellement contenir des batteries ou des substances dangereuses:

- Tableaux de contrôle des instruments
- Séparateur d'amalgames
- Réservoir à sédiments
- Composants du système d'aspiration



CAUTION

DAMAGE FROM UNSUITABLE ACCESSORIES

Responsibility for the use of accessories, parts or assemblies from other manufacturers rest solely with the user.

MISE EN GARDE

DOMMAGES PROVENANT D'ACCESSOIRES INADAPTÉS

La responsabilité de l'utilisation d'accessoires, de pièces ou d'ensembles d'autres fabricants incombe uniquement à l'utilisateur.



CAUTION

CORRECT OPERATING VOLTAGE

Check the correct operating voltage on the rating plate and ensure that the product is correctly configured for the voltage before plugging in and energizing.

MISE EN GARDE

TENSION DE FONCTIONNEMENT CORRECTE

Vérifiez la tension de fonctionnement correcte sur la plaque signalétique et assurez-vous que le produit est correctement configuré pour la tension avant de le brancher et de le mettre sous tension.



CAUTION

SUCTION CANISTER PURGE

LED turns on when suction canister overfills.

MISE EN GARDE

PURGE DE LA CARTOUCHE D'ASPIRATION

La LED s'allume lorsque la cartouche d'aspiration déborde.



CAUTION

POWER SUPPLY CORD

The power supply cord is not replaceable by service personnel.

MISE EN GARDE













CORDON D'ALIMENTATION





Le cordon d'alimentation n'est pas remplaçable par le personnel de service.

IDENTIFICATION OF SYMBOLS

The table below defines symbols that may be included on/in this dental system.

Symbol	Description
	Conforms to UL STD 60601-1; Certified to CSA STD C22.2 NO. 601.1
	Recognized by Underwriters Laboratories Inc. with respect to electric shock, fire, and mechanical hazards only in accordance with UL 61010-1 (2601-1) and under mutual recognition agreement with CAN/CSA C22.2, No.601-1.
	Protective earth (ground)
	Functional earth (ground)

Symbol	Description
	Type B applied part
	Type BF applied part
	Class II Equipment
	Caution: Metal surfaces can be hot during and following the dry cycle.
	Marking on the outside of Equipment or Equipment parts that include RF transmitters or that apply RF electromagnetic energy for diagnosis or treatment.
	Indicates the medical device manufacturer
	Indicates the need for the user to consult the instructions for use.
	Indicates the temperature limits to which the medical device can be safely exposed
	Indicates the range of humidity to which the medical device can be safely exposed
	Medical Device
	Model number
	Conforms to EU MDR 2017/745
	Indicates the manufacture's serial number

Symbol	Description
	<p>Indicates that caution is necessary when operating the device or control close to where the symbol is placed, or that the current situation needs operator awareness or operator action in order to avoid undesirable consequences</p>
	<p>Indicates a carrier that contains unique device identifier information</p>
	<p>Indicates the Authorized Representative in the European Community</p>
	<p>Conforms to UK MDR 2002</p>
	<p>Indicates the date when the medical device was manufactured</p>

Section 2 Contents

Operating Environment & Classification of Equipment

CLASSIFICATION OF EQUIPMENT (EN-60601-1)

ENVIRONMENTAL SPECIFICATIONS

ELECTROMAGNETIC COMPATIBILITY (EMC)

CLASSIFICATION OF EQUIPMENT (EN-60601-1)

Type/Mode	Classification
Types of shock protection	Class I Equipment
Degree of shock protection	TYPE B and/or TYPE BF APPLIED PART depending on order configuration
Degree of protection against water ingress	ORDINARY EQUIPMENT
Mode of operation	Intermittent
Flammable Gasses:	Not suitable for use in the presence of a flammable anesthetic mixture with air, oxygen, or nitrous oxide, where such gasses may accumulate in concentration (closed spaces).

ENVIRONMENTAL SPECIFICATIONS

Temperature/Humidity	Specification
Storage/Transportation Temperature:	-40°C to 70°C (-40°F to 158°F) - Relative humidity 80%
Operating Temperature:	10°C to 40°C (40°F to 104°F) - Relative humidity 80%
Indoor Use:	Altitude up to 2,000M (6,563 ft.), installation category II, pollution degree 2. (UL 61010A-1 and CAN/CSA C22.2, No. 1010.1-92 only)
Maximum Fluid Conductivity:	.0762 Siemens
Exclusions	Hospitals except for near active HF surgical equipment and the RF shielded room of a medical equipment system for magnetic resonance imaging, where the intensity of electromagnetic disturbances is high.

ELECTROMAGNETIC COMPATIBILITY (EMC)

Although this dental equipment conforms to the intent of the 2004/108/EC EMC Directive, all medical equipment may produce electromagnetic interference or be susceptible to electromagnetic interference. The following are guidance and manufacturer’s declarations regarding EMC for this equipment.

This equipment needs special precautions regarding EMC and needs to be installed and put into service according to the EMC information provided in the following pages.



⚠ WARNING

ELECTROMAGNETIC COMPATIBILITY

As with all electrical medical equipment, this equipment may cause radio interference or may disrupt the operation of nearby equipment. It may be necessary to take mitigation measures such as re-orienting or relocating this equipment unit or shielding the location.

COMPATIBILITÉ ÉLECTROMAGNÉTIQUE

Comme pour tous les équipements médicaux électriques, cet équipement peut provoquer des interférences radio ou perturber le fonctionnement de l’équipement à proximité. Il peut être nécessaire de prendre des mesures d’atténuation, telles que la réorientation ou le déplacement de cette unité d’équipement ou le blindage de l’emplacement.

- Portable and Mobile RF communications equipment can affect the performance of this equipment, and should be used no closer than 30cm (12inches) to any part of the ASI dental system. Please use the guidelines and recommendations specified in IEC 60601-1-2, Edition 4.0.

- Other medical equipment or systems can produce electromagnetic emissions and therefore can interfere with the functionality of this equipment. Care should be used when operating the system adjacent to or stacked with other equipment. If adjacent or stacked use is necessary, this equipment should initially be observed to verify normal operation in the configuration in which it will be used.
- The electrical cables, external power supplies and accessories listed or referenced in this manual have been shown to comply with the test requirements listed in the following tables.

Care should be taken to use only manufacturer-recommended cables, power supplies and electrical accessories with this equipment.

If the user or a third-party supplier offers cables, external power supplies and electrical accessories for use with this equipment and they are not listed or referenced in this manual, it is the responsibility of that third-party supplier to determine compliance with the standards and tests in the following tables.

- The use of electrical cables and accessories other than those specified in this manual or referenced documents may result in increased electromagnetic emissions from this equipment or decreased electromagnetic immunity of this equipment.
- The main power switch on the system is also utilized as the main circuit breaker (AC 240V, 16A, 5000A interrupting capacity). Ensure that this circuit breaker is physically accessible at all times when operating the system.

Guidance and Manufacturer's Declaration Electromagnetic Emissions

This equipment is intended for use in the electromagnetic environment specified below. The customer or the end user of this equipment should assure that it is used in such an environment.

Emissions Test	Compliance	Electromagnetic Environment - Guidance
RF Emissions - CISPR 11 (Radiated & Conducted)	Group 1	This equipment uses RF energy only for its internal function. Therefore, its RF emissions are very low and are not likely to cause any interference in nearby electronic equipment.
RF Emissions - CISPR 11 (Radiated & Conducted)	Class A	The emissions characteristics of this equipment make it suitable for use in industrial areas and hospitals. If it is used in a residential environment this equipment might not offer adequate protection to radio-frequency communication services. The user might need to take mitigation measures, such as relocating or re-orienting the equipment.
Harmonic Emissions EN/IEC 61000-3-2	Class A	
Voltage fluctuations/ Flicker Emissions EN/IEC 61000-3-3	Complies	

Guidance and Manufacturer’s Declaration – Electromagnetic Immunity

This equipment is intended for use in the electromagnetic environment specified below. The customer or the end user of this equipment should assure it is used only in such an environment.

Immunity Test	EN/IEC 60601 Test Level	Compliance Level	Intended Electromagnetic Environment
Electromagnetic Discharge (ESD) EN/IEC 61000-4-2	± 8kV contact ± 2kV, ± 2kV, ± 8kV, ± 15kV air	± 8kV contact ± 2kV, ± 2kV, ± 8kV, ± 15kV air	Floors should be wood, concrete or ceramic tile. If floors are covered with synthetic material, the relative humidity should be at least 30%.
Electrical fast transient/burst EN/IEC 61000-4-4	± 2kV for power supply lines ± 1kV for input/output lines	± 2kV for power supply lines ± 1kV for input/output lines	Mains power quality should be that of a typical commercial or hospital environment.
Surge EN/IEC 61000-4-5	± 1kV differential mode (line-line) ± 2kV common mode (line-earth)	± 1kV differential mode (line-line) ± 2kV common mode (line-earth)	Mains power quality should be that of a typical commercial or hospital environment.
Voltage dips, short interruptions and voltage variations on power supply input lines EN/IEC 61000-4-11	0 % UT; 0,5 cycle at 0°, 45°, 90°, 135°, 180°, 225°, 270° and 315° 0 % UT; 1 cycle and 70 % UT; 25 cycles Single phase: at 0° 0 % UT; 250 cycle	0 % UT; 0,5 cycle at 0°, 45°, 90°, 135°, 180°, 225°, 270° and 315° 0 % UT; 1 cycle and 70 % UT; 25 cycles Single phase: at 0° 0 % UT; 250 cycle	Mains power quality should be that of a typical commercial or hospital environment. If the user of this equipment requires continued operation during power mains interruptions, it is recommended that this equipment be powered from an uninterruptible power supply or a battery.
Power frequency (50/60Hz) magnetic field EN/IEC 61000-4-8	3A/m	3A/m	Power frequency magnetic fields should be at levels characteristic of a typical location in a typical commercial or hospital environment.

NOTE: UT is the a.c. mains voltage prior to application of the test level.

Guidance and Manufacturer’s Declaration – Electromagnetic Immunity

This equipment is intended for use in the electromagnetic environment specified below. The customer or the end user of this equipment should assure it is used in such an environment.

Immunity Test	EN/IEC 60601 Test Level	Compliance Level	Intended Electromagnetic Environment
Conducted RF EN/IEC 61000-4-6 Radiated RF EN/IEC 61000-4-3	3Vrms between 0.15MHz to 80MHz 6V/m in ISM bands between 0.15MHz and 80MHz 80MHz to 2.7GHz	3Vrms between 0.15MHz to 80MHz 6V/m in ISM bands between 0.15MHz and 80MHz 80MHz to 2.7GHz	Portable and mobile RF communications equipment should be used no closer to any part of this equipment, including cables, than the recommended separation distance calculated from the equation applicable to the frequency of the transmitter. Recommended separation distance $d = 1.2\sqrt{P}$ $d = 1.2\sqrt{P}$ 80MHz to 800 MHz $d = 2.3\sqrt{P}$ 800MHz to 2.5GHz where P is the maximum output power rating of the transmitter in watts (W) according to the transmitter manufacturer and d is the recommended minimum separation distance in meters (m). Field strengths from fixed RF transmitters, as determined by an electromagnetic site survey (a), should be less than the compliance level in each frequency range (b). Interference may occur in the vicinity of equipment marked with the following symbol: 

Proximity fields meet the minimum requirement of

<i>Test Frequency (MHz)</i>	<i>Band (MHz)</i>	<i>Immunity Test Level (V/m)</i>
385	380-390	27
450	430-470	28
710	704-787	9
745		
780		
810		
870	800-960	28
930		
1720		
1845	1700-1990	28
1970		
2450		
5240	2400-2570	28
5500		
5785		
5785		
5785	5100-5800	9
5785		
5785		

NOTE 1: At 80MHz and 800MHz, the higher frequency range applies.
NOTE 2: These guidelines may not apply in all situations. Electromagnetic propagation is affected by absorption and reflection from objects, structures and people.

a Field strengths from fixed transmitters, such as base stations for radio (cellular/cordless) telephones and land mobile radios, amateur radio, AM and FM radio broadcast and TV broadcast cannot be predicted theoretically with accuracy. To assess the electromagnetic environment due to fixed RF transmitters, an electromagnetic site survey should be considered. If the measured field strength in the location in which this equipment is used exceeds the applicable RF compliance level above, this equipment should be observed to verify normal operation. If abnormal performance is observed, additional measures may be necessary, such as re-orienting or relocating this equipment.
 b Over the frequency range 150kHz to 80MHz, field strengths should be less than 3V/m.

Recommended Separation Distances Between Portable and Mobile RF Communications Equipment and This Equipment

This equipment is intended for use in an electromagnetic environment in which radiated RF disturbances are controlled. The customer or the user of this equipment can help prevent electromagnetic interference by maintaining a minimum distance between the portable and mobile RF communications equipment (transmitters) and this equipment as recommended below, according to the maximum output power of the communications equipment.

Rated maximum output power of transmitter in watts (W)	Separation distance according to frequency of transmitter in meters (m)		
	150kHz to 80MHz $d = 1.2\sqrt{P}$	80MHz to 800MHz $d = 1.2\sqrt{P}$	800MHz to 2.5GHz $d = 2.3\sqrt{P}$
0.01	0.12	0.12	0.23
0.1	0.38	0.38	0.73
1.0	1.2	1.2	2.3
10	3.8	3.8	7.3
100	12	12	23

For transmitters rated at a maximum output power not listed above, the recommended separation distance d in meters (m) can be estimated using the equation applicable to the frequency of the transmitter, where P is the maximum output power rating of the transmitter in watts (W) according to the transmitter manufacturer.

NOTE 1: At 80 MHz and 800 MHz, the separation distance for the higher frequency range applies.

NOTE 2: These guidelines may not apply in all situations. Electromagnetic propagation is affected by absorption and reflection from structures, objects and people.

Section 3 Contents

Product Description, Specifications and Warranty

INDICATIONS FOR USE STATEMENT – DENTAL DELIVERY SYSTEMS

PRODUCT DESCRIPTION

THEORY OF OPERATION

OVERVIEW OF COMPONENTS AND HOW THEY WORK

Handpiece Control and Operation

Tandem Water Disinfection System

LIMITED WARRANTY

INDICATIONS FOR USE STATEMENT – FREEDOM DENTAL SYSTEMS

The ASI Freedom Dental System is a dental treatment unit. It is designed to provide air, water, vacuum, and electricity to operate various dental handpieces, accessories, and attachments and to serve as a base for other dental devices and accessories.

The device is intended for use to provide general dental restorative care and hygiene procedures in both traditional dental office settings and/or mobile applications by or under the supervision of a licensed dentist or a hygienist if permitted by applicable law. Any serious incidents that occur in relation to the device should be reported to the manufacturer and to the competent authority of the relevant location of use.

PRODUCT DESCRIPTION

The Freedom Dental System product is a cart-based operative dental treatment unit requiring connection to an AC electrical power supply, suction, and compressed air supply for operation. The Dental System can be configured for right, left, or ambidextrous users. The product is constructed of aluminum chassis with powder coat paint finish, high grade dual wheel type casters, and composite work surface top. It includes Air Handpiece Connections, Air/Water Syringe with Titanium HVE and Saliva Ejector. Jacketed, ASI White Silk™ Handpiece Tubing with 50” Length and ASI TrueFit™ Articulating Handpiece Holders. One-liter Bottle Water System with 365-day DentaPure Disinfection Cartridge. The product is hard wired with the appropriate type mains plug provided for the electrical specification Model as listed. Includes rear and side-mounted rail system for mounting of accessory brackets and storage bins. The expected service life of the device is 10 years from its manufacture date, though the low-risk nature of the system allows it to be used safely outside of that timeframe so long as it continues to perform to the user’s satisfaction. Systems requiring repairs outside of their service life may no longer be supported by ASI.

THEORY OF OPERATION

The Freedom Delivery System is a pneumatically controlled system that uses standard compressed air for operation of dental tools and accessories and for pressurizing a closed water supply. The system uses air pressure from a foot control to operate air driven tools.

OVERVIEW OF COMPONENTS AND HOW THEY WORK

- Handpiece Control and Operation
- Tandem Water System
- Compressed Air System
- Suction System

HANDPIECE CONTROL AND OPERATION

The dental system utilizes common dental industry type technology for selection and activation of air-driven drills and instruments via a multi-position control block. The block contains individual gasket diaphragms that are held in the closed position by compressed air supplied by the handpiece holders. When a dental handpiece is removed from its holder, the compressed air is relieved off the gasket diaphragms for that particular instrument thereby allowing compressed air and water to flow to the handpiece when the foot control is depressed. The flow rate of this compressed air is controlled by individual stems on the top of the block and the flow of water by individual needle valves with knobs located on the front and side of the dental system.

Electric instruments, such as the ultrasonic handpiece and electric motor, are controlled via the same control block. However, the compressed air that flows from the block is routed to an air/electric switch that uses an air-driven piston to close contacts when activated to thereby send an electric signal for the ultrasonic and electric motor to operate. When the foot control is released, these instruments will then turn off.

The dental system uses an air-driven poppet style foot-control valve that when depressed, will send compressed air to the control block to operate whichever handpiece is removed from its holder. The foot control also features a toggle valve for selecting water to spray from the handpieces. When the toggle is activated and the foot control is depressed, it will allow an air signal to travel through the foot-control tubing to open a water relay valve allowing water to flow to the selected handpiece. When the foot control is released, it will exhaust off the air to the water relay valve and allow it to shut.



TANDEM WATER DISINFECTION SYSTEM

The system features a tandem supply of two 1-liter bottles providing two liters of water for patient procedures. This system is required to be outfitted with a water line cartridge that disinfects and treats the dental unit water to prevent the formation of biofilm in the dental tubing. The tandem supply increases the volume of water available but also saves costs by only requiring the use of one water line cartridge. The system works by allowing water in the second bottle (right) to flow into the first (left) where it then flows through the disinfection cartridge. The water system uses two 1-liter plastic bottles designed for holding pressure. The bottles can be filled with clean tap or distilled water for the source of water supply to the dental handpieces and air/water syringe. The system works by supplying regulated compressed air which pressurizes the water within the bottle and forces it up through the pick-up tubing in the bottle.

It is the responsibility of the user to source and install a water disinfection system, ASI recommends the use of the DentaPure disinfection cartridge. The water-system utilizes a ¼" OD pick-up tube with a male/female luer-lock connection compatible with most dental cartridges. The cartridge should be installed on the left-most water bottle, which includes the luer-lock connection components.



Dedicated Saline Bottle System Upgrade

The optional saline bottle system upgrade uses the same bracket and layout as the standard tandem water system but allows each bottle to be dedicated to a specific selection of instruments. This allows for dedicated irrigation instruments to be supplied a saline solution saline while simultaneously keeping standard dental unit handpieces supplied with water. The routing selector switch on the saline bottle bracket allows for a water flush function which clears irrigation handpiece lines of solution and particle build-up. The system works by supplying regulated compressed air separately to each bottle without allowing liquid to transfer between them, creating separate fluid outlet lines for each bottle.

Optional External Irrigation Roller Pump System

ASI Advanced Dental Systems have the option of adding an external irrigation system, which includes a speed-controlled roller pump as well as an IV bag hanger. This option provides accommodation for those who want to use their own external saline fluid bag and tubing. The system is used by hanging the user-supplied saline bag onto the IV hanger, then loading the connected tubing into the roller pump by lifting open the top and inserting the tubing. Delivery speed can be adjusted via the control knob located next to the pump.

COMPRESSED AIR

The dental system is provided with a standard dental air line for supplying compressed air to the dental system. The air line is 1/4" outside diameter (O.D.) and has a 1/8" inside diameter (I.D.). The dental system also includes a combination master air supply assembly with regulator and internal air filter, and a standard angle stop with a manual shut-off valve. The angle stop has a 5/8" compression fitting inlet to connect onto 1/2" copper pipe which must be installed by a licensed plumber. The outlet of the angle stop has a 3/8" compression fitting to accept the connector from the master air supply. Air supplied to the dental system should be oil-free and regulated to a standard dental system pressure of 75 to 80 psi. The 1/4" air line is connected directly to the master air supply assembly.

An optional quick connect (Model 90-2744) can be ordered to allow easy disconnection of the air supply. This is ideal for cart type dental systems, allowing carts to be used in different operatories or for serviceability. The quick connect uses a Parker brand 3/8" type which is commonly used in the dental industry for compressed air. The 3/8" male quick connect is placed on the air line to the cart and the 3/8" female quick connect is placed on the line to the air supply. The back end of the quick connects have reducers to adapt to the 1/4" tubing.

The optional ASI dental suction system is designed to provide suction to perform dental procedures and features a high-volume suction and saliva ejector attached to a solid collector filter.

OPTIONAL SUCTION CONNECTIONS AND PIPING RECOMMENDATIONS

ASI supplies suction line tubing made from a special grade of material that is inert to common caustic irrigants and disinfectants used in dentistry. The suction tubing has a 5/8" inside diameter (ID). Included with suction packages are PVC adapters to connect the 5/8" tubing to either 1/2" or 3/4" PVC pipe. If using 1/2" copper pipe for suction, the tubing can simply be slipped over the pipe and clamped into place.

Recommendation

PVC pipe is recommended for suction plumbing lines and NOT copper, as the copper can corrode from some of the caustic irrigating and disinfectant solutions used in dentistry, such as sodium hypochlorite. Check your local building codes to see which piping materials may be used for suction lines.

For cart systems, an optional quick connect (Model 90-2769) is available to allow the suction hose to the cart to be disconnected. It comes with a 5/8" barb that plugs into the receptacle half and a blank plug to seal the outlet if the hose is disconnected.

For systems with optional micro evacuation that are not connected through a solids trap, a separate 3/8" white suction line will be provided. Depending on the configuration, there are a few different ways to connect this tubing. It may be connected straight to a PVC elbow with the provided adaptor, or you may need to tee off the main suction line. Two size tees are provided, one is for a 5/8" ID tubing, or one is for 3/4" ID tubing

Pipe Junctions – Housings and Concealment

It is recommended to cover the area where the pipe stubs and connections are made to prevent them from being bumped into and to conceal them within the operatory. If a computer or monitor will be attached to the delivery system, it is advisable to have network cables run through the same area as the plumbing to manage all the various tubing, wires, and cables. An optional junction box housing is available from ASI. This allows the plumbing and electrical to run within the wall between two studs. A decorative trim panel is then placed over the wall with cut-outs for the umbilical lines. The location in the wall should be approximately 12" to 18" off the floor and should be near where the cart will be placed.

LIMITED WARRANTY - REVISION JUL 2025

ASI Medical, Inc., dba ASI Dental Specialties (ASI) warrants this product against defects in material and/or workmanship for one year for parts, 90 days for labor, from the time of delivery. During this coverage period, ASI's sole obligation will be to repair, adjust, or replace defective parts only. ASI is not responsible for any time lost, inconvenience caused, or for any other incidental or consequential damages. Any unauthorized aftermarket modification of an ASI device may result in unforeseen hazardous situations. Only ASI-certified replacement components should be used for repair or device modification. The warranty shall be voided by alteration, tampering, improper installation or maintenance, accidental damage, or misuse of the product.

This warranty is made in lieu of all other warranties, expressed or implied, including any implied warranty of merchantability of fitness for a particular purpose. No employee, agent, franchise, dealer, or other person is authorized to give any warranties of any nature on behalf of ASI, except as provided herein.

ASI shall have no liability or responsibility to the customer, any other person, or entity with respect to any liability, loss, or damage caused directly or indirectly by the product. Notwithstanding the above limitations and warranties, ASI's liability hereunder for damages incurred by the customer or others shall not exceed the amount paid by the customer for the particular product involved.

ASI shall not be responsible for any warranty work done without first obtaining consent from ASI.

Specific Warranty Modifications

The following items and/or occurrences are not covered under the warranty:

- Accidental Damage & Theft, including but not limited to the following:
 - Damage from accident or misuse including cuts, tears, and crushes to tubing, cracks in suction solids trap filters, housings, broken casters, etc.
 - Damage from use including scratches, dings, dents, and deterioration to paint and overlays
 - Theft or vandalism
- Damage from Neglect or Improper Maintenance, including but not limited to the following:
 - O-ring lubrication to all valves including the air-water syringes and foot controls
 - Flushing of handpieces or micro-irrigation lines
 - Removal of condensation from air lines
 - Obstructions in water lines and handpiece tubing caused by foreign particles or chemical agents dispensed through the lines
 - Obstructions in suction lines caused by foreign particles or improper maintenance of trap filters
- Disposable Type Items including but not limited to the following:
 - Light bulbs, all filters, gaskets, O-rings, and certain types of tubing.

Modifications to Design

Modifications to equipment made by or on behalf of the customer to the equipment that alter its performance, function or design such as connection to external municipal water supplies or installation or replacement of internal components are excluded from warranty coverage.

Specific Warranty Modifications for Self-Contained Dental Systems

The following items and occurrences are not covered under warranty for Self-Contained Systems with Internal Air Compressor and Suction Systems:

- **Damage, Clogs, or Malfunctions to Canister and Purging System.** The warranty coverage excludes the suction canister, its components, the purge pump of the suction system, and the tubing due to the inability of ASI to control items and solutions that the user may pull into the suction system (adhesives, cement, polishing powders, impression materials, caustic irrigants, etc.), and the unpredictable maintenance regime to mitigate clogging or malfunction.
- **Damage to Vacuum Pump from Liquid Contamination.** The waste canister has an overflow float switch that will cut power to the vacuum pump in the event the canister begins to over fill. This will prevent liquid and other contaminants from being pulled into the internal pistons of the vacuum pump. However, improper maintenance can result in a malfunction of the overflow float switch or constant overfilling of the canister can result in liquid contamination of the vacuum pump. This type of damage is specifically excluded from warranty coverage.
- **Damage to Vacuum Pump and Air Compressor from Chemical Vapor Contamination.** If certain caustic chemicals used in dental procedures (specifically bleach used in Endodontic procedures) is repeatedly used in concentrated forms without rinsing with water, this can cause highly concentrated gases to be pulled into the vacuum pump and air compressor system, causing corrosion to the internal working components. Corrosion damage to the vacuum pump or the air compressor system from chemical gases is specifically excluded from warranty coverage.

Specific Supplemental Electronic Instrument Warranty

As a convenience to our customers, ASI offers to install new or used brands of instruments, not manufactured by ASI, into our dental systems. This benefit enables customers to configure their dental systems with various instruments and to realize the cost savings of incorporating already owned instruments. ASI's standard one-year warranty is further modified for these installed instruments, as follows:

ASI's supplemental warranty does not extend the original term of the manufacturer's warranty, does not include items not covered under the manufacturer's warranty, or warranty problems caused by, or resulting from, misuse or accidental breakage.

Any installed instruments requiring repair will need to be removed and sent back to the respective manufacturer for inspection and repair. It will be the responsibility of the customer for any labor costs incurred in the removal, replacement, shipping, or packaging of these instruments. ASI will not be responsible for these costs or the ability of the manufacturer to complete any necessary repairs in a timely manner.

ASI will provide a supplemental warranty for a period not to exceed one year from the date of purchase of new components from other manufacturers installed into ASI dental systems. This supplemental warranty is only valid in the event a component manufacturer declines to honor its warranty due to the component's removal from its original housing. In the event the manufacturer declines to honor its warranty for an item that otherwise would have been covered, ASI will reimburse the customer for the amount of the repairs billed by the instrument manufacturer, not to exceed the selling price of the instrument.

Replacement Parts Limited Warranty

Replacement parts (either purchased or replaced at no charge warranty) do not affect or extend the original warranty term provided. New replacement parts are provided with a 90-day warranty term from the time of

shipment and do not include any other costs such as labor for installation, removal, or shipping. These separate costs are the responsibility of the customer. Soft goods such as filters, tubing, gaskets, O-rings, bulbs, etc. are not covered under warranty due to damage that can occur by handling or improper installation. All other terms, modifications, and exclusions provided in the dental system warranty apply to replacement parts.

Section 4 Contents

Unpacking and Installation

UNPACKING

ELECTRICAL INSTALLATION

UNPACKING

Carefully remove all packaging material from around and underneath the dental system and remove the accessory box, which may contain additional items required for installation. Inspect the dental system for any obvious signs of shipping damage. If any damage is discovered, immediately contact our Customer Service Department at (800) 566-9953 or (303) 766-3646.

Roll the dental system to its location on a level surface. Place the handpiece tubings, air/water syringe, and optional instruments into their respective holders. Position the foot control and tubing on the floor toward the front of the dental system.

Locate the clean water system inside the door or the side of the dental system. Fill the bottles with clean water or other approved solutions. Please refer to the Clean Closed Water System for more information.

The cart then needs to be connected to a central air supply, appropriate electrical supply and optional vacuum and water supply. Connection of umbilical lines from the cart to an appropriate junction box are the responsibility of the user and should only be performed by knowledgeable individuals. The tubing is color coded to assist with connection. If the cart is connected to a plumbed water supply, the water pressure must be regulated to 35 psi or less. Ensure that the main power switch is fully accessible based on the chosen installation configuration.

ELECTRICAL INSTALLATION

The dental system is equipped with a high grade rated SJT power cord and hospital grade plug. By design, the plug is to be placed into a standard 115-volt 60-Hz outlet. Generally, contractors will provide a duplex or quadplex box that can be floor or wall mounted. For dental systems shipped outside of North America with 230-volt 50 Hz service, you will need to supply the correct plug per your country's electrical code.

- i** ***IMPORTANT REQUIREMENT: Due to the sensitive nature of the electrical components installed in the dental system, the electrical supply should be made to a dedicated AC circuit with an isolated ground to provide line noise rejection and computer-grade electrical current.***

STARTING UP

Tandem Water System

Air/Water Syringe

Handpieces

Fiber Optics

HANDPIECE OPERATION

Fiber Optics Operation

Verify Handpiece Operation

Handpieces Holders

Coolant Operation – Adjusting Coolant Spray

Adjusting Chip Air Flow

Oil Mist Recovery Jar

OTHER INSTALLED INSTRUMENTS

ORAL EVACUATION SYSTEM

STARTING UP

Tandem Water System

The clean water system (see figure) features easy-to-fill, pressurized water bottles that enable you to control the quality of water to your handpieces and air/water syringe. The water bottle is made of non-porous plastic. The bottle is reusable, but should be replaced periodically. See maintenance schedule section.



How It Works

Air, regulated to approximately 35 psi, is supplied to the water bottles through tubing attached to the pressure heads. The air pressure in the bottle forces clean water from the water bottle into the water pick-up tube and out to the handpiece control blocks, syringe, and auxiliary quick connects. The water system is a “closed system,” allowing control of water quality and water system asepsis. The Tandem System works by allowing the second bottle to flow into bottle one to provide an uninterrupted two-liter supply.

Filling the Bottles

Locate the clean water system mounted inside the dental system behind the door. Locate the toggle switch for supplying air pressure to the bottles. Flip the switch to the OFF position to turn off the air supply to the bottles.

Slowly unscrew the bottles to allow them to depressurize. Clean as appropriate. Fill the bottles with clean, demineralized water to the fill line on bottle label. Re-attach the bottles and hand tighten only.

Operating the Tandem Water System

Turn the air pressure toggle switch to the ON position and allow the system to pressurize. The system will now provide solution to the dental system and corresponding handpieces. Water may flow from bottle two to bottle one.

Disinfecting the Water System

Refer to Section 6 - Cleaning and Disinfection Section of this manual for disinfection of the clean water system and handpiece tubings.

Purging Water from the System

Running compressed air through the water lines is an easy and effective way to remove water from the lines and prevent stagnant water from residing in the lines during temporary or long-term storage of the system. To purge the water, remove the bottles and completely empty them of their liquid contents. Then, replace the bottles and turn on the air pressure supply to the bottles. Run the handpiece connections and air water syringe until there is no more water particles exiting them.

Air/Water Syringe

Air/Water and Air Only Syringe Adjustment

Adjustment knobs are located and labeled on either the front or side of dental system. Check the flow of air, water and spray from the syringe. Press the right button for water stream. Press the left button for air. Press both simultaneously for spray. To adjust the flow of air, turn the syringe air adjustment knob clockwise to increase, counter-clockwise to decrease. To adjust the flow of water, turn the syringe water adjustment knob until the desired level of flow is achieved (see figure).



Tip Removal and Replacement

The air/water syringe is a press ring type which accommodates metal or disposable tips supplied by others. To remove the tip, press down on the outside collar (left figure). When you feel a soft click the tip may be pulled straight out (right figure). Hold the collar down and insert the new tip, pressing it all the way in. Release the collar and test installation. Pull on the tip assuring proper insertion and that the locking mechanism is engaged.



Handpieces

Verify Handpiece Placements

Ensure all handpieces are placed into their correct holders and that the corresponding tubing is correctly situated. This dental system uses auto holders that activate the instrument once it is removed. If any instruments are incorrectly placed into holders, the selected instrument by the operator will fail to work. Verify all tubings hanging straight down are not crossed and are placed in sequential order from left to right on the holder bar. This will ensure they are placed correctly.

Handpiece Pressure

Handpiece pressure is regulated by the control block, and has been preset at the factory for standard handpiece settings. To determine pressure, a handpiece must be attached before reading the rectangular gauge located on the front of the dental system. Refer to the handpiece manufacturer’s manual for pressure settings. To adjust the handpiece pressure, refer to the service section of this Operation Manual.



Handpiece Connections and Fiber Optics Operation

Prior to connecting any air driven handpiece, it is important to determine the type of connection required for the brand and style of handpieces you desire to use.

Standard Four-Hole Connection

The pneumatic connections supplied are a standard connection used in the dental industry which will accommodate handpieces made in accordance with ISO standards. The connection provides the following functions:

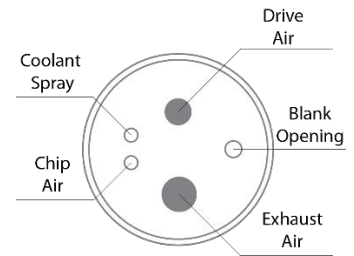

- 1 **Drive Air** This air pressure travels up the tubing to operate/drive the turbine in high-speed handpieces or the air motor in air low-speed handpieces.
- 2 **Exhaust Air** As the drive air leaves the turbine or air motor, it exhausts down this tubing and exits in an oil mist recovery jar. The oil mist recovery jar helps to trap small droplets of oil used to lubricate the handpiece.
- 3 **Chip Air** An air stream which blows onto the cutting bur; assists in removing debris and aids in visibility and cutting while using a high-speed handpiece. Also used to atomize coolant spray, generating a fog mist instead of just a stream of water. To adjust coolant spray it is important to adjust the volume of chip air. It may also be turned off to help prevent air from blowing into a treatment such as a surgical procedure. Not all air driven high-speed handpieces are ported for chip air, so it is important to verify this option is available for the brand of handpiece being used.
- 4 **Coolant Spray** The coolant spray allows water to flow up to high-speed handpieces and to be sprayed onto the bur.
- 5 **Blank Hole** This hole is non-operative, but is intended to still allow the use of a fiber optic handpiece in the standard non-fiber optic connection.

Fiber Optics

If the dental system is equipped with fiber optic tubing you will need to ensure the configuration is correct for your handpiece. To determine the style of fiber optics you will need for your handpiece, look at the back of your handpiece or the swivel coupler and compare the connections to the following drawings. For bulb replacement please refer to Service section of this manual.

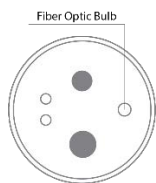

Five-Hole Fiber Optic Systems

These systems are an adaptation of the four-hole handpiece connection, adding a fifth hole for the light to enter the back of the handpiece. The light travels from the bulb up through the swivel coupler and through the handpiece via fiber optic glass rods.

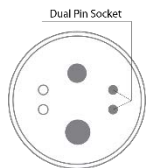

Six-Pin Fiber Optic Systems

Instead of having the small bulb in the connector at the end of the tubing, the bulb is contained in the swivel coupler of the handpiece. The connector at the end of the handpiece tubing has two electrical sockets. The swivel coupler has two electrical pins that drop into these sockets when it is attached.

Attaching Handpieces

Once the correct handpiece configuration has been determined, the handpieces can be attached. Ensure that the handpiece you will be using has a gasket at the end, and that it is in good condition to prevent potential air/water leaks.

The handpiece connection has very fine threads and a gasket on the back end that must screw onto the tubing tightly in order to seal correctly. For new handpieces it is recommended to screw on the handpiece tubing, then loosen and clean threads and then screw on again to ensure a tight seal fit on the gasket to prevent air and water leaks.

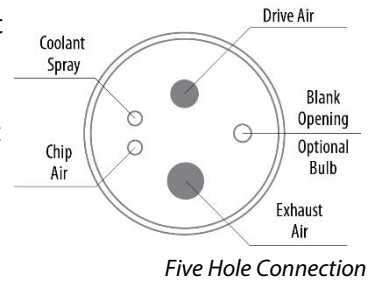

Attaching Non-swivel Handpieces

Place the handpiece onto the coupler and ensure that the tubes from the handpiece align in the connector, and that the gasket on the back of the handpiece is seated against the connector. Then firmly tighten the metal nut onto the handpiece. To get a good seal, it may be necessary to slightly unscrew the metal nut and then retighten to secure.

Attach Swivel Coupler onto Handpiece Connector

For handpieces that have a swivel coupler at the base, use the following instructions. The manufacturer’s handpiece/coupler wrench is required.

- 1 Remove the quick connect coupler from the handpiece; see first figure below.
- 2 Insert coupler into handpiece connector, carefully align the coupler to handpiece connector, making sure the rubber gasket touches; see second figure below.
- 3 Firmly tighten the coupler into handpiece nut. Use the manufacturer’s small flat wrench to hold coupler while tightening, if necessary.
- 4 Place handpiece onto the quick connect coupler; see third figure below.

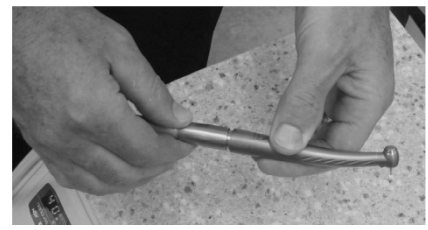

HANDPIECE OPERATION

Refer to the handpiece manufacturer’s instructions for the use and maintenance of the handpiece prior to use. Handpiece operation is performed by pressing down on the foot control to run and then removing pressure from the foot control to stop. A handpiece will only run if it has been removed from its holder and the lock-out switch disengaged (see Handpiece Holders section below).

Fiber Optics Operation

In order for fiber optics to work, the fiber optic handpiece must be attached to the handpiece tubing. Once the handpiece tubing has been removed from its holder, press the foot control to activate the fiber optics.

Verify Handpiece Operation

Handpiece instruments can be picked up and operated briefly by pressing the foot control. Verify fiber optic illumination systems light and operation of other instruments. Water can also be sprayed from instruments to ensure it is working correctly.

Handpieces Holders

The handpieces are automatically activated for use with the foot control whenever they are removed from their holder. (Ensure that only one handpiece is removed from the holder at a time to prevent multiple handpiece activation. If so equipped, engage the handpiece lockout feature for additional safety.)

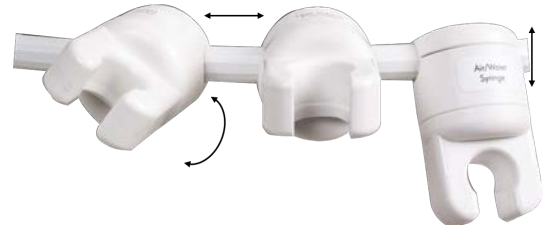

Handpiece holders can slide from side to side on the bar, they can ratchet around the bar, and they can be rotated.

Coolant Operation – Adjusting Coolant Spray

To activate the coolant water for a handpiece, flip the toggle switch either located on the front of the dental system or on the foot control. To deactivate the coolant water, flip the toggle switch to the OFF position.

To adjust coolant spray, press the foot control and while the handpiece is operating, locate the adjustment knob on the dental system on the side or front. Turn the toggle switch for coolant spray to ON, then turn the adjustment knob (counter-clockwise to decrease, or clockwise to increase) until the desired level of spray is achieved (see figure).

- i** *For multiple instruments that provide coolant, individual adjustments are provided and are located in order from left to right, and are labeled accordingly.*



Adjusting Chip Air Flow

The Chip Air Control is located on the front left side of the dental system and is labeled. To adjust, rotate clockwise to increase and counter-clockwise to decrease the flow. Depending on the brand of handpiece, chip air may be used to create the desired atomization of the coolant spray. It may also be desired to shut down chip air flow for some treatment procedures. In this case, rotate the knob counter clockwise until it stops.

Oil Mist Recovery Jar

Air from an air driven handpiece is exhausted through the tubing and exits through the oil mist recovery jar. The oil mist recovery jar helps to trap droplets of excess oil used in handpiece lubrication.



OTHER INSTALLED INSTRUMENTS

Please refer to Section 10 – References or Supplemental Information, for separate instructions for each individual instrument that may be installed as an accessory in the dental system.

ORAL EVACUATION SYSTEM

To use an evacuation handpiece, remove the valve from the holder and insert the desired tip into the valve. The saliva ejector valve accommodates standard disposable saliva ejector tips and the HVE valve accommodates standard disposable 7/8" tips.

To ensure maximum suction flow, periodically check and replace the solids trap screen located on the front of the dental system. Remove the cover to the solids trap, lift out the old screen, insert the new screen and replace the cover to the solids trap.

EQUIPMENT CARE AND INSPECTION

Inspection

Solids Trap Filter

Oil Mist Jar

Exterior Cleaning and Worktop

Worktops and Control Panel Overlays

Painted Work Surfaces and Handpiece Holders

Wiping Down/Disinfecting Handpiece Tubings

Disinfection of Clean Water System

Handpiece Sterilization

Syringe Tip Sterilization

Suction Handpiece Sterilization

HVE & SALIVA EJECTOR/EVACUATION SUCTION HANDPIECES

Suction Tips

High-Volume Evacuator/Saliva Ejector Handpiece Bodies

SHUTDOWN AND STORAGE

Prepare for Storage

EQUIPMENT CARE AND INSPECTION

The equipment should be thoroughly cleaned and disinfected after use each day to maintain optimal performance. All components should be maintained in proper working order and replaced as required.

Inspection

The following visual checks and inspections should be performed before operating the dental system:

- Look for mechanical damage that could affect safe operation
- Ensure there are no missing parts or accessories.
- Inspect components for tightness, cracks, wear or frayed electrical cords.
- Should mechanical or other damage be evident that would affect the safe use or operation of the dental system, it should not be used until repair or replacements correcting the defects are made.

Solids Trap Filter

Check the solids trap filter daily, and replace it if the filter has become clogged. ASI recommends replacing the filter at least once per week to prevent loss of suction strength.

i See *Infectious Materials Warning in Section 1 before beginning.*

- 1 Remove the lid. (Replace with PN 95-0121, if needed)
- 2 Lift out the filter. Dispose of the solids trap filter according to your hazardous waste protocol.



- 3 Check the O-ring on the lid of the solids trap for cracks or stretching, resulting in loss of suction strength. (Replace with PN 95-0091L, if necessary)
- 4 Replace the filter (PN 95-0088).
- 5 Close the lid.

Oil Mist Jar

The dental system utilizes a container to assist in capturing excess handpiece lubricant. This Oil Mist Recovery Jar is located under the left side of the dental system behind the holder bar. Exhaust lines of the pneumatic handpiece connections are routed through it and then exhausted out through the jar lid port. The jar uses standard 2 by 2 gauze to capture oil mist droplets from the exhaust air. The gauze should be replaced every three months or whenever it becomes visibly noticeable that it is discolored from oil mist. To change: unscrew the jar, remove and dispose of the old gauze. Unfold a new gauze, fluff it up, place it in the jar and reattach.



Exterior Cleaning and Worktop

The exterior of the dental system should be thoroughly cleaned and disinfected after use each day to maintain optimal performance. All components should be maintained in proper working order and replaced as required.

Worktops and Control Panel Overlays

The worktop is either an engineered quartz top or a solid surface polymer top. The overlays are plastic with transparent windows. Do not use abrasive pads on these surfaces as it will scratch and damage them. Only use soft cloth or sponge with mild detergent type solutions that can disinfect.

Follow the guidelines listed below to keep your composite solid surface worktop looking as good as new.

- Most dirt and stains - use soapy water or ammonia-based cleaner
- Water marks - wipe with damp cloth; towel dry
- Disinfecting - occasionally wipe surfaces with diluted household bleach (1 part water/1 part bleach)

Painted Work Surfaces and Handpiece Holders

Do not spray detergents or solutions directly into openings on the cart or the ball valve of the holder, as this may damage internal components. If you are using a spray solution, please spray onto a soft cloth or sponge before wiping down these surfaces.

The use of non-foaming wipes can also be used on these surfaces. Avoid frequently using brands where ammonium or bleach is the active ingredient as the residue left behind can degrade components on the dental system.

Wiping Down/Disinfecting Handpiece Tubings

Handpiece tubing can be wiped down with non-staining disinfecting solutions. It is best to use disinfecting wipes with a hydrogen peroxide base, as those are the least likely to cause yellowing or staining.

- ***Do not use Cavicide or other brands that are known to cause yellow staining on the tubing. The residue can degrade plastics and metals.***

Disinfection of Clean Water System

It is recommended to use the DentaPure Cartridge DP365B (or Dpi365B for European users) in the clean water system bottles to disinfect the water system. The DP365B is designed for use for one year without requiring daily maintenance. The system can accommodate most cartridge-based dental disinfection systems.



- i** *The DP365B cartridge is available for purchase directly from ASI for North American customers. Order PN 95-0281 at ASISupport.com.*
- i** *To order the Dpi365B cartridge visit the following website and contact the vendor listed based on the country you are located in. <https://hufriedygroup.eu/en/where-buy>*

To use, the cartridge can be attached to the pick-up tube that hangs down in the water bottle by screwing it into the supplied fitting. To replace, unscrew the old cartridge and screw in the new one. Place the Date Changed label on the outside of the clean water system as a reminder of when the next change is required.

- i** *Do not use the DentaPure DP365B or DPi365B Cartridge for longer than its rated one-year period. The cartridge will no longer provide disinfection for the dental system and may plug the dental system and obstruct the water flow. Do not use the DentaPure DP365B or DPi365B if using a shock treatment to disinfect lines as it will damage the cartridge. The cartridge must be removed and a standard tubing used in the bottle for performing shock disinfection treatment of the water system. Do not use bleach to disinfect the water system. Due to its caustic nature, it can corrode certain internal parts. Any damage is excluded from warranty coverage. The user assumes all responsibility for maintaining and disinfection of the water system, and for periodically having water sample tests performed to ensure that disinfection is satisfactory.*

There are many other established methods for disinfecting a closed water system that consist of liquids, powders and tablets. However, the chemicals used in these cleaners may damage the materials of the diaphragms used in the control block and other valves in the dental system. Further, tablets may not dissolve completely and may cause blockage of the water system. Any damage to the dental system as a result of the use of these alternate cleaners is excluded from warranty coverage.

Handpiece Sterilization

Follow all manufacturer's instructions for sterilization of any optional accessories and dental handpieces made by others.

Syringe Tip Sterilization

Several methods of sterilization may be used, please follow the syringe tip manufacturer's instructions whenever possible.

ASI recommends a steam autoclave for sterilizing the ASI reusable syringe tips:

- Thoroughly rinse and clean tips prior to sterilization, as debris may reduce the effectiveness of sterilization.
- Wrapped syringe tips should be sterilized at 132°C (270°F) for 15 minutes at temperature with a 30-minute drying time when using a gravity displacement autoclave.
- Unwrapped syringe tips should be sterilized at 132°C (270°F) for 3 minutes at temperature when using a gravity displacement autoclave.
- Pressure requirements vary depending on geographic location of autoclave user.

Suction Handpiece Sterilization

This dental system and the attachments offered with it (air/water syringe, saliva ejector, and high-volume evacuator [HVE]) are not provided sterile. In addition to the disinfection of these parts, a disposable barrier sleeve may be used to cover the air/water syringe, saliva ejector and HVE. The disposable barrier sleeve must be discarded and replaced between each patient.

HVE & SALIVA EJECTOR/EVACUATION SUCTION HANDPIECES

Suction Tips

The suction handpieces are designed for use with disposable tips which should not be reused. If using a reusable metal tip supplied by others, it must be properly sterilized before each use, per that manufacturer's instructions.

High-Volume Evacuator/Saliva Ejector Handpiece Bodies

Barrier film is one recommended way to protect the main body of the HVE and saliva ejector/micro evacuator. If using a barrier film, the handpiece bodies should be cleaned weekly or more frequently as needed. Another recommended sterilization technique is autoclaving.

To autoclave the HVE and Saliva Ejector/Micro Evacuator

- 1 Turn off the vacuum before disconnecting the suction handpieces.
- 2 Remove the tip from the suction handpieces.
- 3 Remove the HVE or saliva ejector valve/micro evacuator body from the tubing by pulling it away from the tubing to disconnect from the barb end that remains in the tubing.
- 4 Remove the control valve spool from them main body by sliding out from the side (see figure).
- 5 Unscrew the nose piece from the saliva ejector/micro evacuator.
- 6 Clean and rinse the valve body, control valve spool and nose piece using a mild detergent, water and soft bristled brushes if necessary to remove debris.
- 7 Allow all parts of the suction handpieces to dry completely.
- 8 Place the body, control valve spool and nose piece in a steam autoclave for at least 15 minutes at a temperature of 121(±1)° Celsius with a minimum of 15 minutes dry time.
- 9 Apply a light coat of ASI Silicone O-Ring grease lubricant to the O-ring seals and the circumference of the control body spool and re-insert into the body of the handpiece.
 - Order ASI PN 95-0085-1, Silicone O-Ring Grease (1 tube) or 95-0085 (5 tubes)
- i** **CAUTION – Use only silicone lubricant when lubricating instrumentation O-rings. Petroleum products will cause permanent damage to the O-rings.**
- 10 Reattach the handpiece to the tubing barb end of the respective tubing for the handpiece.



- 11** Operate the HVE and Saliva Ejector valves several times to verify that they rotate smoothly.

Replacement Parts:

- Viton O-ring for Control Valve Spool and Tubing Barb [PN 95-0506]
- Viton O-ring for Saliva Ejector Tip [PN 95-0507]
- Viton O-ring for Saliva Ejector/Micro Evacuator Tubing Barb [PN 95-0503]
- Silicone O-ring Grease [PN 95-0085-1]



SHUTDOWN AND STORAGE

Prepare for Storage

To prepare for either storing or shipping, follow the instructions below:

- 1** Empty the water containers and purge handpiece coolant lines and the water syringe. See Operation Instructions. Run air through the handpieces for an additional three minutes to air dry.
- 2** Remove and dispose of solids trap filter and the HVE and saliva ejector tips. Run suction to both the HVE and Saliva Ejector open for three minutes to air dry.
- 3** Unplug the dental system from power and carefully wind the power cord around the brackets on the rear of the cart.

BASIC TROUBLESHOOTING GUIDE

Troubleshooting the Dental System

Handpiece or Instrument does not Operate

Not Enough Pressure to the Handpiece

Air or Water Coming out of Handpieces When Hung Up

Water Filling Up Oil Mist Recovery Jar

Water Not Flowing From Handpieces or Air/Water Syringe

Water Flows from Air/Water Syringe but not Handpieces

Water Dripping After Using a Handpiece

Water Squirts out of Handpiece When Removed from Holder

Syringes Leaking

Foot Control Sticking or Leaking Air

BASIC TROUBLESHOOTING GUIDE

The following information is intended to assist with some common issues that could arise with the dental system. Many issues can be resolved or repaired without any special equipment or training.

Troubleshooting the Dental System

The dental system should be maintained and given proper care. If something does go wrong, the information contained herein explains what can be done prior to arranging for or attempting repairs. Additional information may be available in Technical Guides covering the individual components located on the dedicated website ASISupport.com.

Handpiece or Instrument does not Operate

- Verify the ball actuator in the base of the holder has activated out.
- Make sure the correct adjustment stem on the control block portion for that handpiece has been opened to allow air to flow to the handpiece or activation switch for electric instruments.

Not Enough Pressure to the Handpiece

- Low pressure from compressor or regulator. Ensure 75 to 80 psi prior to adjusting handpiece block.
- Make sure the correct adjustment stem on the control block portion for that handpiece has been opened.
- Ensure that the exhaust air tubes and oil mist recovery jar are allowing the air to exhaust freely. Verify that there is no kinked exhaust tubing to the oil mist recovery jar or any obstructions such as cotton two-by-twos in the exhaust port of the jar lid.
- Ensure that only one air-driven handpiece is being lifted out of the holder at one time. If multiple handpieces are in use, the pressure will decrease on each of them.
- Diaphragm(s) in control block may need to be replaced if over five years old or if the dental system has been over pressurized.
 - Order ASI PN 95-0215, *Control Block Diaphragm Pucks Full Set* and refer to the applicable technical guideline (located on ASISupport.com) for more information.
 - Order ASI PN 95-KIT2B, *Delivery System 5 Year Maintenance Kit*
- Check to be sure the handpiece gaskets are secure. These are located on the back end of the handpiece or the swivel coupler. The handpiece tubing nut also needs to be firmly tightened onto the handpiece in order to seal against this gasket.
- Make sure the bulkhead gasket is secure where it connects to the dental system and there are no cracks.
 - Order ASI PN 95-0206, *Gasket, 4-Hole 7/8" Silicone*
- Check for kinks in the foot control tubing. The air that runs the handpiece is coming all the way from the foot control. Any kinks or bends can restrict the air and limit the pressure.
- A worn-out handpiece consumes more air to operate than a new one. Check to see if the turbine is the problem by switching to another handpiece and checking the pressure. Follow handpiece manufacturer's recommendation for repairing handpiece.

- The handpiece quick connect coupler or swivel coupler may be clogged and not allowing the air to exhaust from the handpiece. Remove the coupler from the tubing and try a different coupler. Another way to test a bad coupler is to move it to a different tubing that previously worked fine. Does the problem exist with the coupler on a different tubing? If so, replace or repair the coupler by following the coupler manufacturer's recommendation.

Air or Water Coming out of Handpieces When Hung Up

- Diaphragm(s) in the control block are worn or have holes from improper water line disinfection chemicals, over pressurized air supply or over five years old. Replace the diaphragm(s).
 - Order ASI PN 95-0215, *Control Block Diaphragm Pucks Full Set* and refer to the applicable technical guideline (located on ASIsupport.com) for more information.
 - Order ASI PN 95-KIT2B, *Delivery System 5 Year Maintenance Kit*

Water Filling Up Oil Mist Recovery Jar

- Bad gasket on handpiece or coupler is not tight or is mis-threaded. Remove handpiece coupler, verify gasket and firmly re-tighten.
- Water condensation from main air compressor is in the air lines. Check central compressor.
- If the diaphragm pucks have recently been replaced, and the jar is overflowing with water, the pucks may be upside down in the control block. Open the control block and verify that the ridged side of the diaphragm puck is facing towards the adjustment stem on side of block.

Water Not Flowing from Handpieces or Air/Water Syringe

- Check the water bottles and ensure they are full, switched on and that the air pressure gauge is reading around 25-35psi.
- If the pressure is below 25 psi, then the check valve needs to be replaced.
 - Order ASI PN 95-0216, *Mini-Inline Regulator, 35psi, 1/16" Barbs* and refer to the applicable technical guideline (located on ASIsupport.com) for more information.
- Air leak in pickup tube or cartridge not secure onto pickup tube. Secure or replace tubing if necessary.
- Bottle threads worn and not sealing correctly. Replace bottles annually or sooner if necessary.
- Blocked or pinched tubing. Make sure tubing is not pinched. If tubes are not pinched, inspect for blockage.

Water Flows from Air/Water Syringe but not Handpieces

- Pinched water line.
- Check to see if water is not flowing from any handpiece to determine if it is isolated to just one tubing. Ensure that all the flow control valves for water have been opened.
- Check the water on/off toggle located either on the foot control or on the dental system to see if it is working. Remove the cover on the foot pedal from the toggle to see if the signal line could be kinked. Remove the gray air signal line from the relay and activate the foot pedal and ensure that an air stream is coming out.
- Press straight down on the water on/off toggle and activate. If water flow resumes, replace toggle tower assembly if defective.
 - Order ASI PN 95-0242, *Foot Control Toggle Assembly Wet/Dry*

- Check the water output side of the relay by disconnecting the tubing from the relay to the control block and pressing the foot control. If still no flow, replace the water relay valve.
 - Replace with ASI PN 95-0135; *Water Relay Valve* and refer to the applicable technical guideline (located on ASIsupport.com) for more information.

Water Dripping After Using a Handpiece

- Check for air in the water line. Run the handpieces for a minute or two to clear any air bubbles out of the water system then check the air water syringe connection at the bulkhead to be sure it is tight and secure.
- If water drips from only one handpiece, check to see if there is a cracked connector in either end of the handpiece tubing or the bulkhead itself. Replace the bulkhead or handpiece tubing (*see ASIsupport.com for tubing options and part numbers*).
- For dental systems with a foot control toggle switch, check the foot control signal line. If there is a slight kink in the foot control tubing, it can delay the air from exhausting off the relay and allows water to drip. Replace if necessary.
 - Replace with ASI PN 95-0242 *Foot Control Toggle Assembly Wet/Dry* and refer to the applicable technical guideline (located on ASIsupport.com) for more information.
- If water drips from several handpieces or if water slowly builds and drips out, the water relay may not be working or has a small piece of debris in it. Replace the water relay valve.
 - Replace with ASI PN 95-0135 *Water Relay Valve* and refer to the applicable technical guideline (located on ASIsupport.com) for more information.

Water Squirts out of Handpiece When Removed from Holder

- The water relay valve is stuck open allowing water to flow and may need to be replaced. Check the foot control tubing is not kinked and holding air pressure on the plunger which will hold the valve open. Replace valve if required.
 - Replace with ASI PN 95-0135 *Water Relay Valve* and refer to the applicable technical guideline (located on ASIsupport.com) for more information.

Syringes Leaking

- If air or water keeps flowing, the button O-rings are worn and require that the button cartridges be replaced. Button O-rings may need to be greased with Silicone O-Ring grease.
 - ASI PN 95-0089, *Syringe Repair Kit*
 - ASI PN 95-0085-1, *Silicone O-Ring Grease (1 tube)*
- **i** *Use only silicone lubricant when lubricating instrumentation O-rings. Petroleum products (such as Vaseline®) will cause permanent damage to the O-rings.*
- Spray mist occurs when depressing air valve immediately following water valve depression can be caused by worn nozzle assembly O-rings. Replace O-rings.
 - Replace with ASI PN 95-0089, *Syringe Repair Kit* and refer to the applicable technical guideline (located on ASIsupport.com) for more information

Foot Control Sticking or Leaking Air

- If the disc is sticking or leaking air, the dental system may need either a rebuild kit or grease the valve O-rings with silicone O-ring grease.
 - ASI PN 95-0240, *Foot Control Repair Kit*
 - ASI PN 95-0085-1, *Silicone O-Ring Grease (1 tube)*
 - **i** *Use only silicone lubricant when lubricating instrumentation O-rings. Petroleum products will cause permanent damage to the O-rings.*
- If air is blowing out of foot control, the diaphragm in the control block may have a hole in it allowing hold-back air from the handpiece holders to leak through the block and out of the foot control. Replace the control block diaphragm.
 - Replace with ASI PN 95-0215 *Control Block Diaphragm Pucks Full Set* and reference Technical Guideline (located on ASIsupport.com).

CUSTOMER SUPPORT

REPLACEMENT PARTS

List of Replacement Parts/Kits for this System

SERVICE

PREVENTATIVE MAINTENANCE DAILY, 1-YEAR & 5-YEAR CHECKLIST

CUSTOMER SUPPORT

For technical assistance with installation, operation or service, please visit our dedicated Service Website at **ASISupport.com**. There you will be able to review operation and service tips, technical guidelines, and email a technical request ticket or call directly to speak with someone on our technical support team.

To facilitate service, please have the serial number of your system available.

REPLACEMENT PARTS

Replacement parts may be ordered directly online at **ASI.Parts**

List of Replacement Parts/Kits for this System

- Check Valve Repair Kit PN 95-0108
- Solids Trap Canister PN 95-0247
- Water Relay PN 95-0135
- Bulkhead Connector, 4-hole, 7/8” PN 95-0189
- Air Driven High Speed and Low Speed Tubing
 - 60” Tubing length PN 95-0202W
 - 50” Tubing length PN 95-0203W
- Syringe Repair Kit PN 95-0089
- Water Bottle, 1-liter, 38mm PN 95-0347
- DentaPure Waterline Disinfection Cartridge (North America) PN 95-0281
- Control Block Diaphragm Pucks, Full Set PN 95-0215
- Control Block, 5-Position, Titanium PN 95-0295
- Fiber Optic Tubing
 - 60” tubing length, 6-pin PN 95-0477
 - 50” tubing length, 6-pin PN 95-0475
 - 60” tubing length, 5-hole w/LED PN 95-0476
 - 50” tubing length, 5-hole w/LED PN 95-0474
- Fiber Optic Power Pack PN 95-0229
- Ultrasonic Handpiece Cord PN 95-0123L
- Ultrasonic Newtron Module PN 95-0198
- Master Air Regulator PN 95-0178C
- Felt Dust Filter PN 95-0093
- Transformer, Dual Output, 24 VAC, 9 VAC PN 95-0300
- Foot Control, Wet/Dry Toggle PN 95-0254
- Water On/Off Toggle Assembly PN 95-0242
- Foot Control Rebuilt Kit PN 95-0240

SERVICE

Please follow the following steps for service of your equipment.

- ① **Start with Section 7 - Troubleshooting** This section is designed to help narrow down most common problems.
- ② **Visit ASIsupport.com – Tech Support – Learning and Knowledge Center** ASI’s support website contains a vast array of instructions, including short videos, and is available 24/7.
- ③ **Contact ASI Tech Support** If you still have questions, reach out to one of our Customer Service representatives, who can further assist you.
- ④ **“Find a Technician”** It is highly recommended that you have a qualified technician provide service, repairs, and routine maintenance for your system, ASIsupport.com can help you find an independent technician in your area.

IMPORTANT! *Before servicing your system, carefully read and fully adhere to all cautions and warnings.*

PREVENTATIVE MAINTENANCE DAILY, 1-YEAR & 5-YEAR CHECKLIST

DELIVERY SYSTEMS	Daily	1-Year	5-Years
Verify handpiece pressure gauge is operational. Check for crack or air leaks. Replace pressure gauge (PN 95-0136), if needed.		X	
Run a handpiece and verify operation of water relay valve for opening and shutting off. Recommended replacement of water relay valve (PN 95-0135) every 5 years.		X	
Test all handpieces for proper air pressure, water function. Using the stems on the control block, make adjustments. Replace control block diaphragms (PN 95-0215) every 5 years.		X	
Check all gaskets in the handpiece tubing bulkheads. Replace gaskets (PN 95-0206) every 5 years.		X	
Inspect and replace handpiece tubing if worn, brittle, or hardened.		X	
Verify operation of auto holders that actuator ball freely moves in and out. Clean with hot water and paper towel, if necessary, to remove any debris.		X	

FOOT PEDAL	Daily	1-Year	5-Years
Install repair kit every 5 years. Serial Number specific: <ul style="list-style-type: none"> ▪ PN 95-0240 [SN 595369 and later] 			X
Check water toggle for proper function. Replace water toggle (PN 95-0242), if needed.		X	

CLOSED WATER SYSTEM	Daily	1-Year	5-Years
Turn air pressure toggle to ON. Verify closed water system gauge is operational. Check for cracks or air leaks. Replace gauge (PN 95-0266) if needed.		X	
Verify air pressure is 25-35 psi. If high or low, inspect inline regulator by pressing in on both ends. If pressure does not adjust within pressure setting, replace regulator (PN 95-0216).	X		
Replace 1-liter water bottles annually: <ul style="list-style-type: none"> ▪ PN 95-0347 for 38mm neck size 		X	
Replace DentaPure disinfection cartridges annually (PN 95-0281).		X	

AIR/WATER SYRINGE	Daily	1-Year	5-Years
Inspect tubing for wear, kinks and damage. Replace tubing if needed every 5 years. <ul style="list-style-type: none"> ▪ PN 95 0213 [60" Length] ▪ PN 95-0214 [50" Length] 		X	
Verify operation of air and water buttons and absence of leaks. Install syringe repair kit (PN 95-0089), if necessary. Recommended replacement every 1-3 years.	X		

FIBER OPTICS AND OTHER ELECTRIC INSTRUMENTS	Daily	1-Year	5-Years
Check integrity of fiber optic tubing if worn, brittle or hardened. Inspect wires for break and proper connection to power pack. Replace tubing, fiber optic bulb, power pack, if needed. <ul style="list-style-type: none"> ▪ PN 95-0477 [60" Length, 6-pin] ▪ PN 95-0475 [50" Length, 6-pin] ▪ PN 95-0476 [60" Length, 5-hole w/LED] ▪ PN 95-0474 [50" Length, 5-hole w/LED] 	X		
Check integrity of other electric instrument cords and repair or replace if jacket is worn or torn.	X		
Replace air electric switches, if included, every 5 years: <ul style="list-style-type: none"> ▪ PN 95-0137 [Normally Open] ▪ PN 95-0138 [Normally Closed] 			X

OPTIONAL SUCTION INSTRUMENTS AND ACCESSORIES	Daily	1-Year	5-Years
Inspect solids trap lid O-ring for wear. Lubricate using silicone O-ring grease (PN 95-0085). Replace solids trap lid (PN 95-0091L) if needed.	X		
Inspect solids trap housing for cracks. Replace, if needed <ul style="list-style-type: none"> ▪ PN 95-0247 [Side Port] ▪ PN 95-0175 [Bottom Port] 		X	
Inspect all suction tubing for leaks or damage. Replace, if needed. <ul style="list-style-type: none"> ▪ PN 95-0287W [HVE] ▪ PN 95-0288W [Saliva Ejector] 		X	
Replace suction lever O-rings (PN 95-0506) and connector barb O-rings (PN 95-0503).		X	

STRUCTURAL	Daily	1-Year	5-Years
Verify all doors, drawer hinges and latches are undamaged. Tighten fittings and lubricate, if needed.		X	
Cart Systems: Clean wheels and casters of all debris.	X		

FOR UMBILICAL DENTAL SYSTEMS ONLY	Daily	1-Year	5-Years
Verify air pressure from main air connection is 75-80 psi; adjust if needed. ASI dental systems risk damage if air pressure is set too high and will void the warranty		X	

GENERAL

Delivery System Tubing

Control Block Diagrams

Foot Control Diagram

Standard Syringe

Closed Water System

Instrument Component, Pan View

SINGLE VOLTAGE SYSTEMS

Wiring Schematics, 115V

DUAL VOLTAGE SYSTEMS

Wiring Schematic, Dual Voltage

DELIVERY SYSTEM TUBING

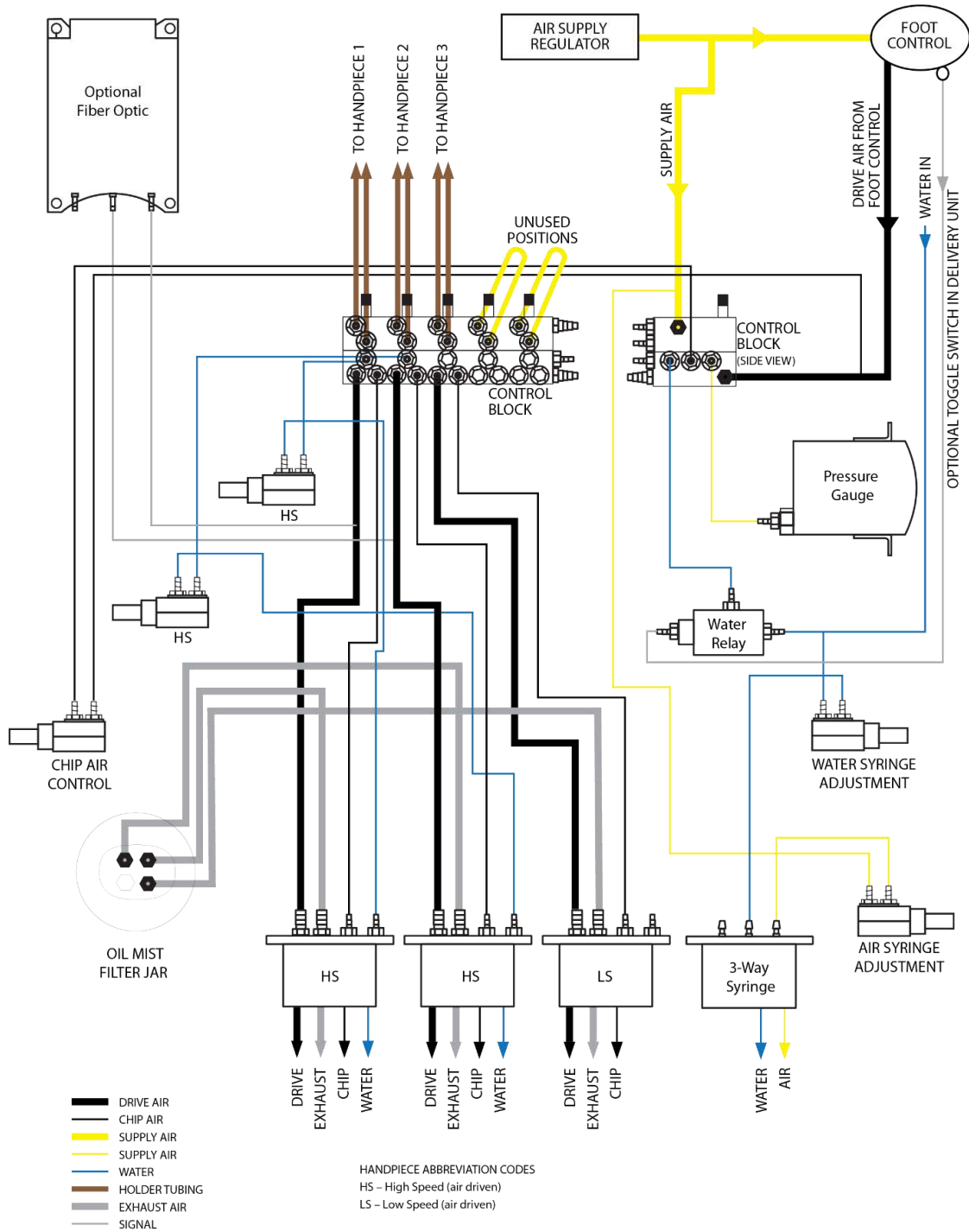

5-POSITION CONTROL BLOCK – FRONT OUTPUT CONNECTIONS TO HANDPIECE

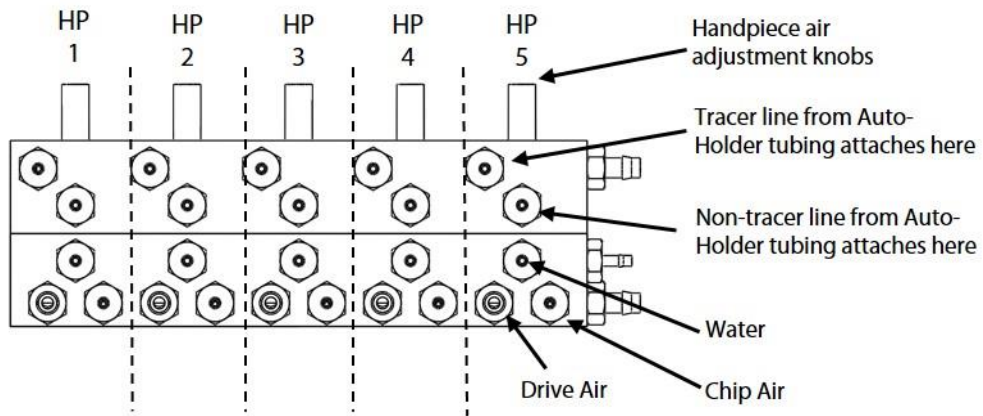

5-POSITION/SINGLE CONTROL BLOCK – SIDE INPUT CONNECTIONS

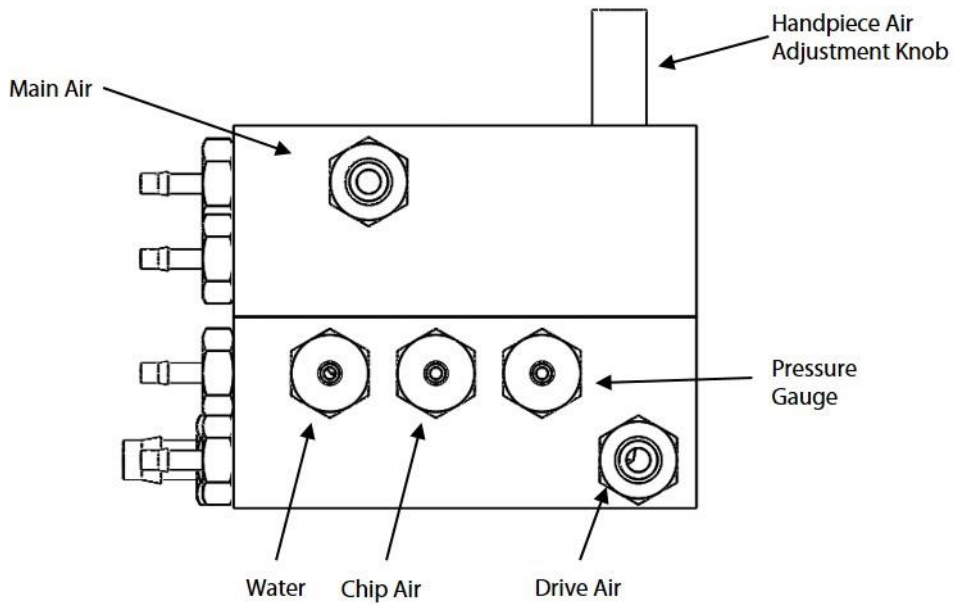

FOOT CONTROL

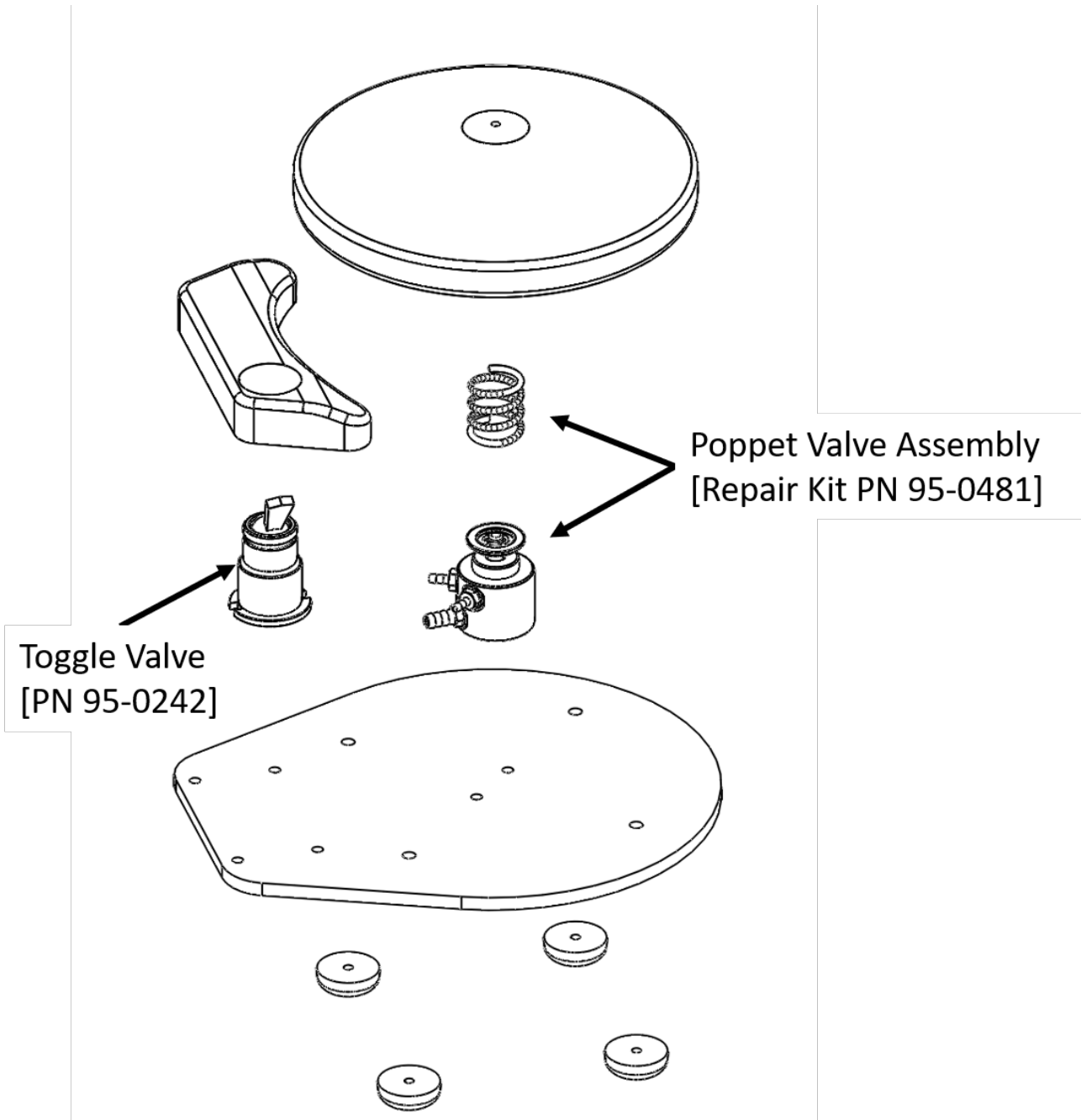

AIR/WATER SYRINGE

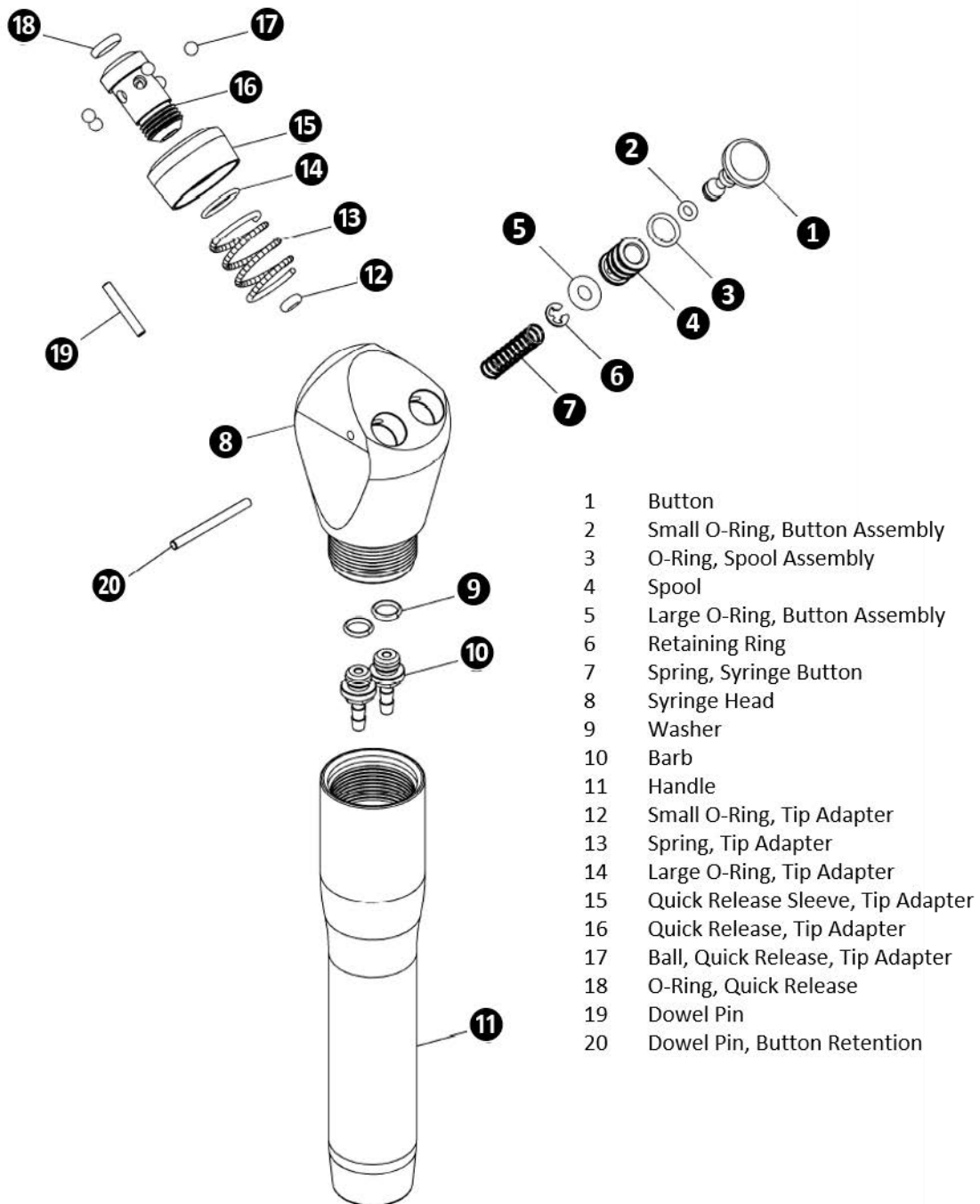

- 1 Button
- 2 Small O-Ring, Button Assembly
- 3 O-Ring, Spool Assembly
- 4 Spool
- 5 Large O-Ring, Button Assembly
- 6 Retaining Ring
- 7 Spring, Syringe Button
- 8 Syringe Head
- 9 Washer
- 10 Barb
- 11 Handle
- 12 Small O-Ring, Tip Adapter
- 13 Spring, Tip Adapter
- 14 Large O-Ring, Tip Adapter
- 15 Quick Release Sleeve, Tip Adapter
- 16 Quick Release, Tip Adapter
- 17 Ball, Quick Release, Tip Adapter
- 18 O-Ring, Quick Release
- 19 Dowel Pin
- 20 Dowel Pin, Button Retention

CLOSED WATER SYSTEM

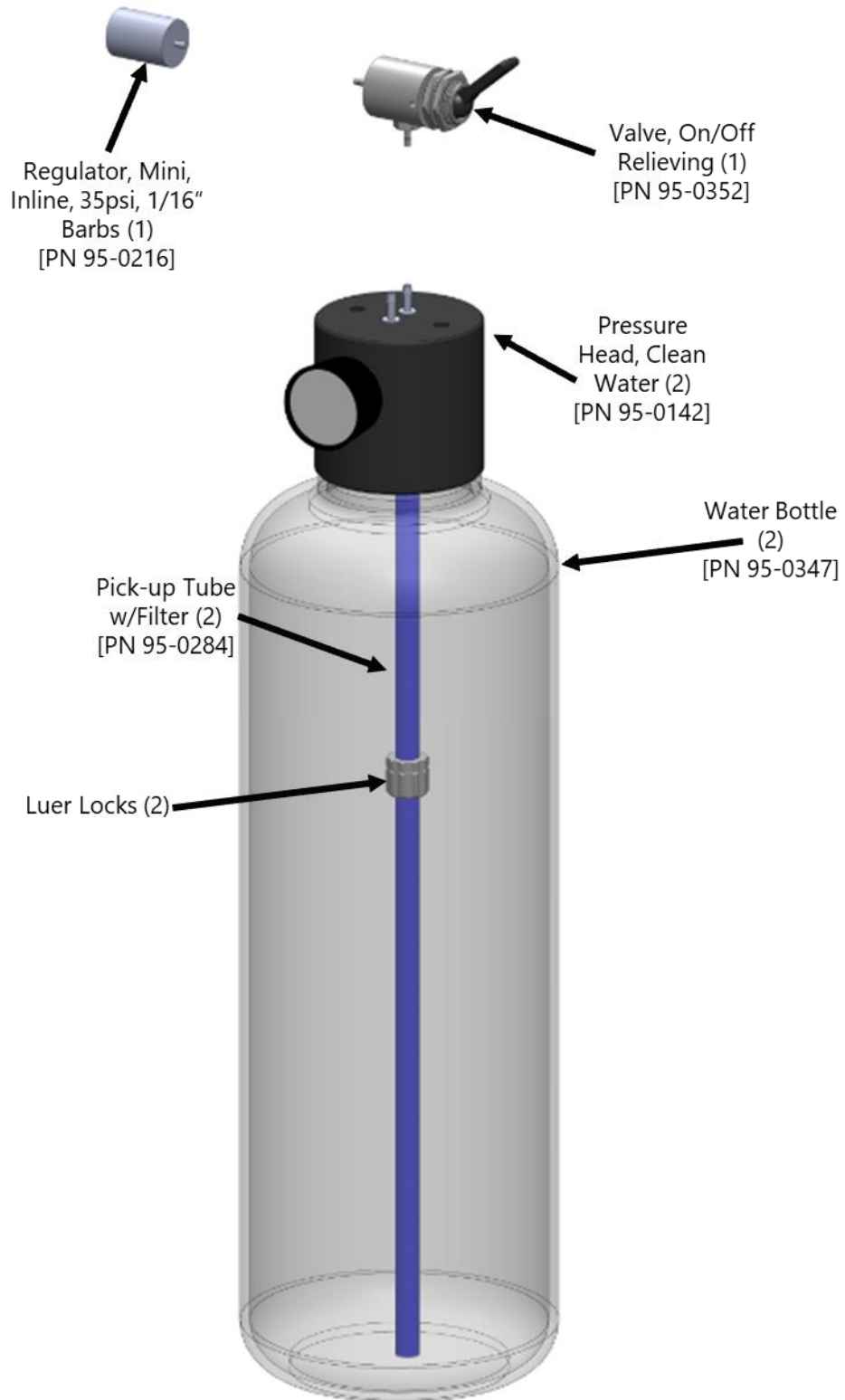

INSTRUMENT COMPONENTS

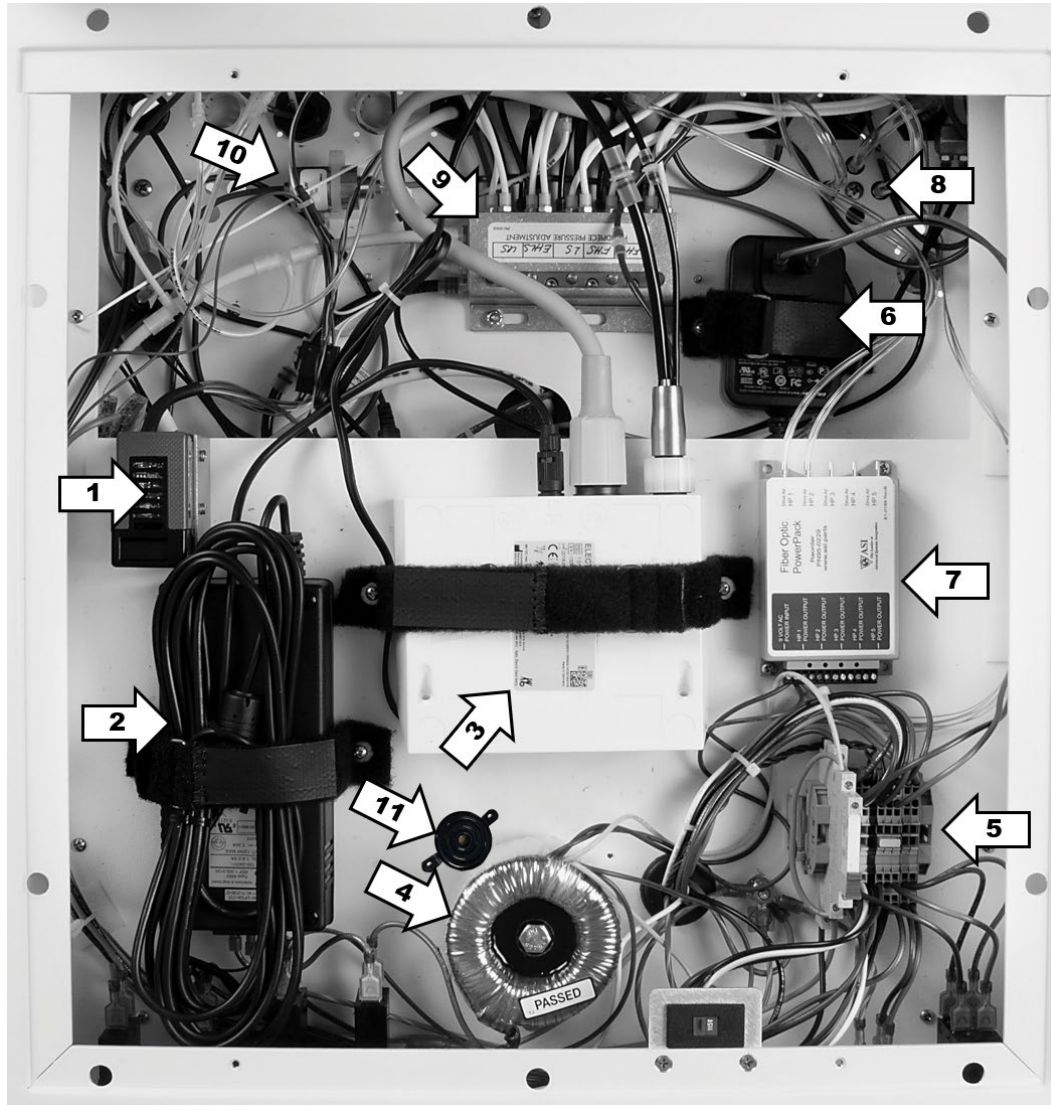

- | | |
|---|--|
| <ul style="list-style-type: none"> ❶ Piezo Ultrasonic Newtron Module (1)
[PN95-0198] ❷ Power Supply, Kavo Motor (1) ❸ Power Controller, Kavo Motor (1) ❹ Transformer Dual Output 24 VAC, 9VAC (1)
[PN 95-0300] ❺ Main Terminal Block (1) ❻ Power Supply, Curing Light (1) | <ul style="list-style-type: none"> ❼ Controller Fiber Optic System (1) [PN 95-0229] ❽ Oil Mist Recovery Jar, Handpiece Exhaust (1)
[PN 95-0258] ❾ Control Block, 5-position (1) [PN 95-0295] ❿ Water Relay Valve (1) [95-0135] ⓫ Alarm/Buzzer (1) [40-0100] |
|---|--|

WIRING FOR CART BASEPLATE, 115V

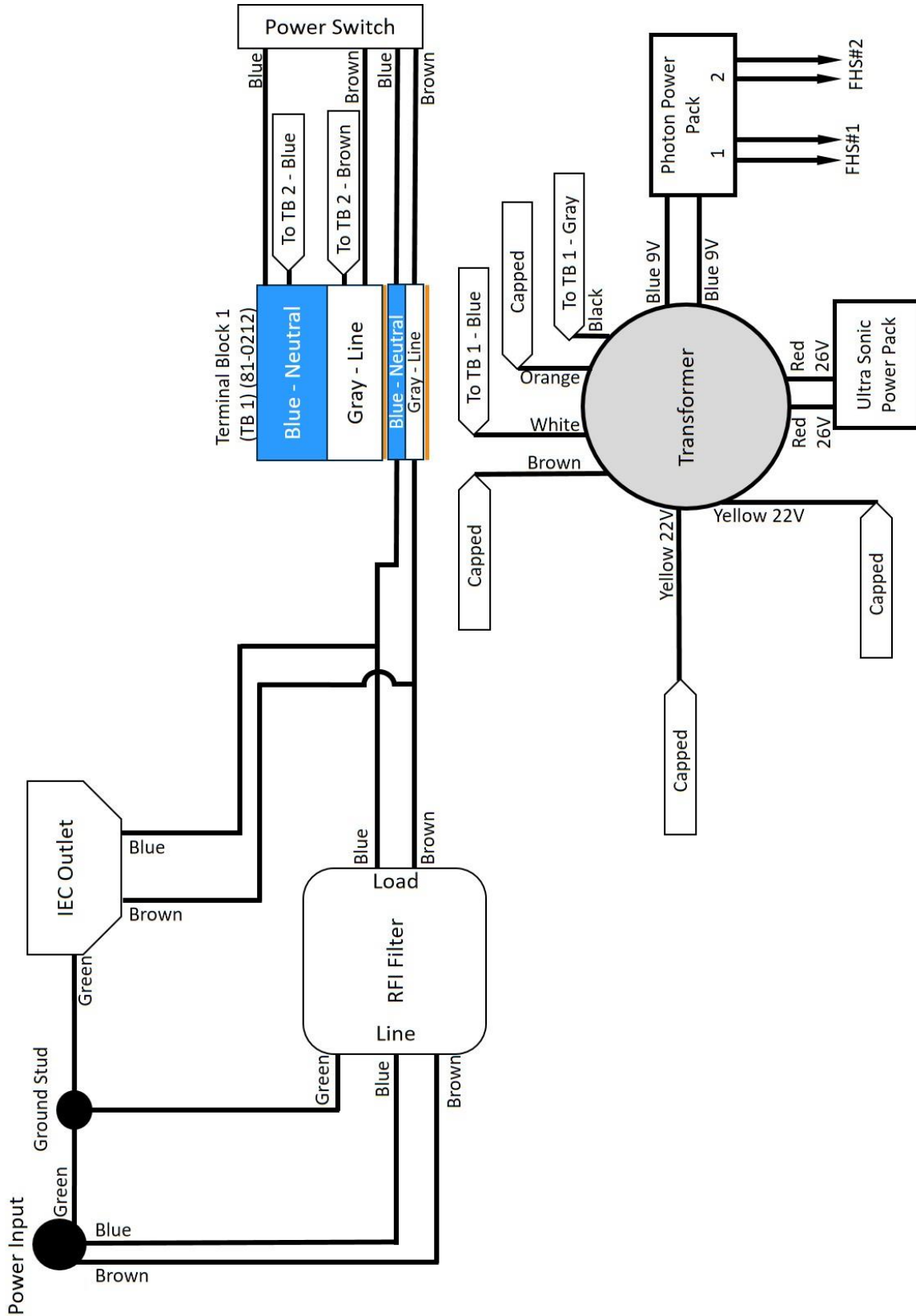

WIRING FOR DUAL VOLTAGE BASEPLATE

